

EMERGENCY VEHICLES, INC.

*Garner EMS & Rescue Squad, Inc.
Garner, North Carolina*

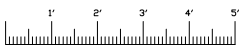
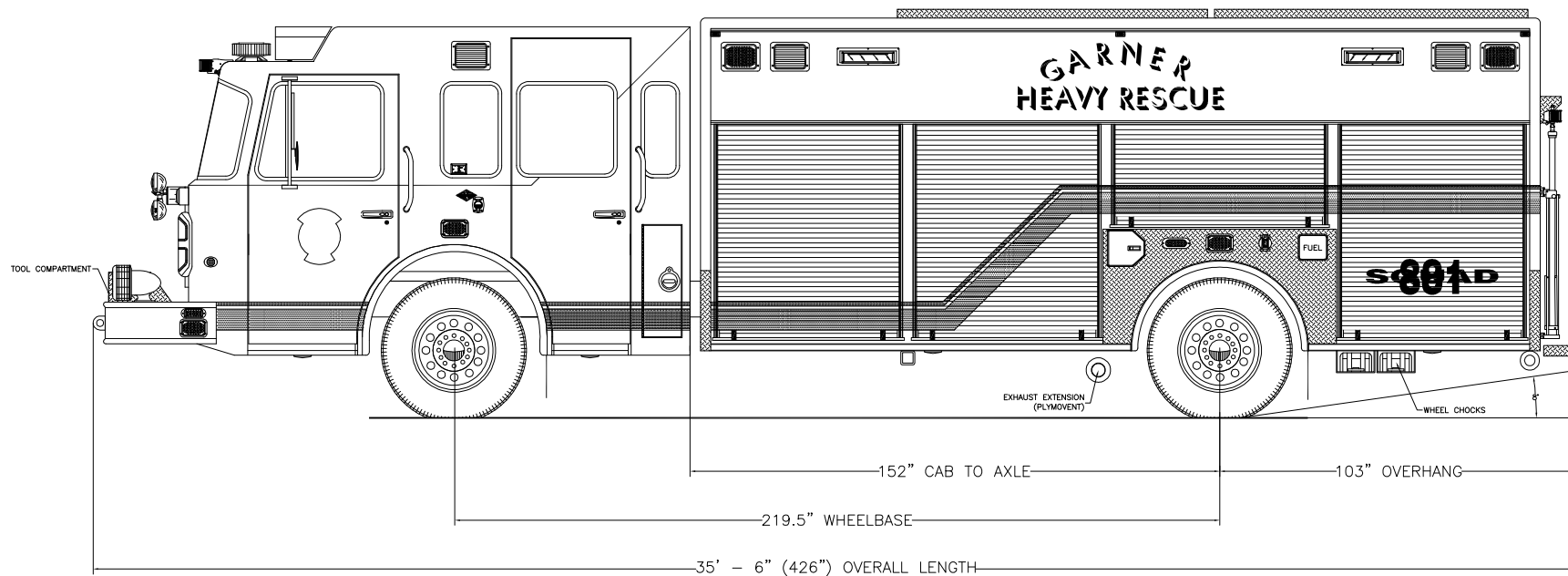

Streetside Overall

THESE DESIGN/ENGINEERING DRAWING(S) ARE THE PROPERTY OF EMERGENCY VEHICLES, INC. THEY ARE PROPRIETARY, AND ARE FOR THE EXCLUSIVE USE OF YOUR ENTITY. ANY DIVULGING OF THIS DATA TO A THIRD PARTY IS PROHIBITED.

[Signature] DATE: 03/31/06

REVISION 1	NS - 09/12/06
REVISION 2	NS - 11/21/06
REVISION 3	-
REVISION 4	-
REVISION 5	-

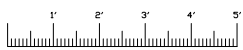
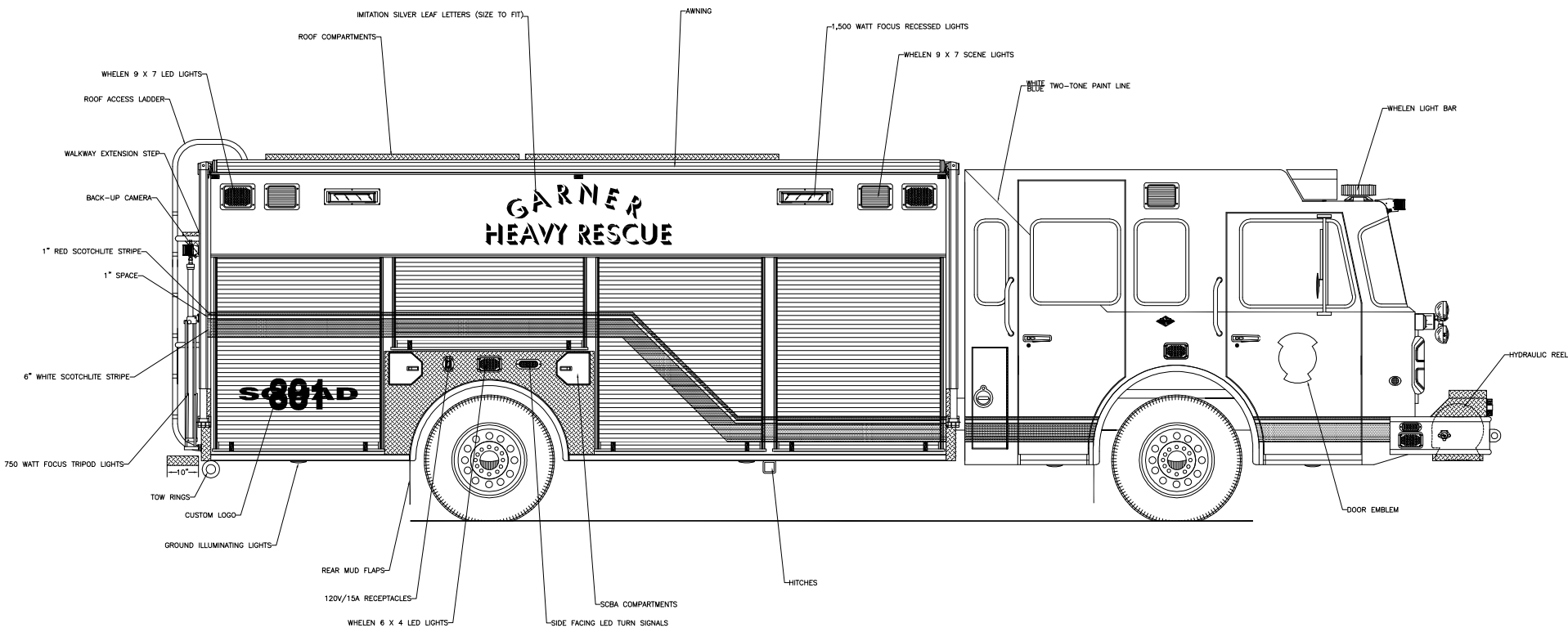

THESE DESIGN/ENGINEERING DRAWING(S) ARE THE PROPERTY OF EMERGENCY VEHICLES, INC. THEY ARE PROPRIETARY, AND ARE FOR THE EXCLUSIVE USE OF YOUR ENTITY. ANY DIVULGING OF THIS DATA TO A THIRD PARTY IS PROHIBITED.

[Signature] DATE: 03/31/06

REVISION 1	NS - 09/12/06
REVISION 2	NS - 11/21/06
REVISION 3	-
REVISION 4	-
REVISION 5	-

Curbside Overall

EMERGENCY VEHICLES, INC.

*Garner EMS & Rescue Squad, Inc.
Garner, North Carolina*

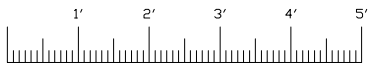
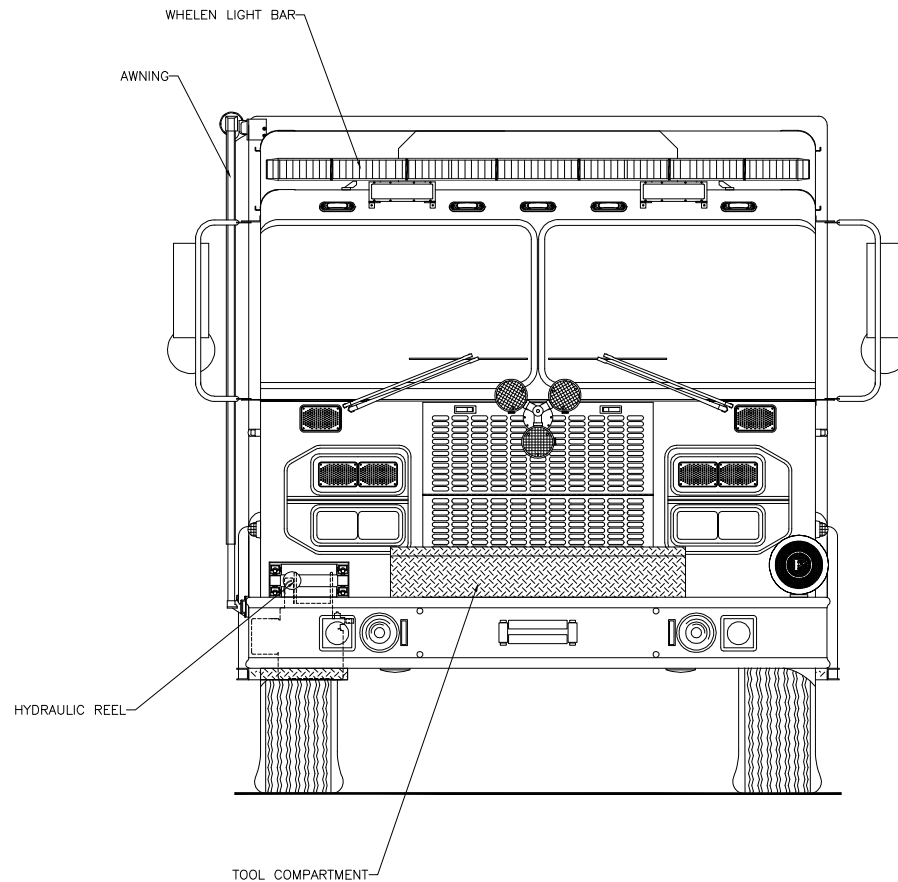

Front View

THESE DESIGN/ENGINEERING DRAWING(S) ARE THE PROPERTY OF EMERGENCY VEHICLES, INC. THEY ARE PROPRIETARY, AND ARE FOR THE EXCLUSIVE USE OF YOUR ENTITY. ANY DIVULGING OF THIS DATA TO A THIRD PARTY IS PROHIBITED.

[Signature] DATE: 03/31/06

REVISION 1	NS - 09/12/06
REVISION 2	NS - 11/21/06
REVISION 3	-
REVISION 4	-
REVISION 5	-

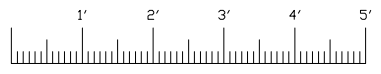
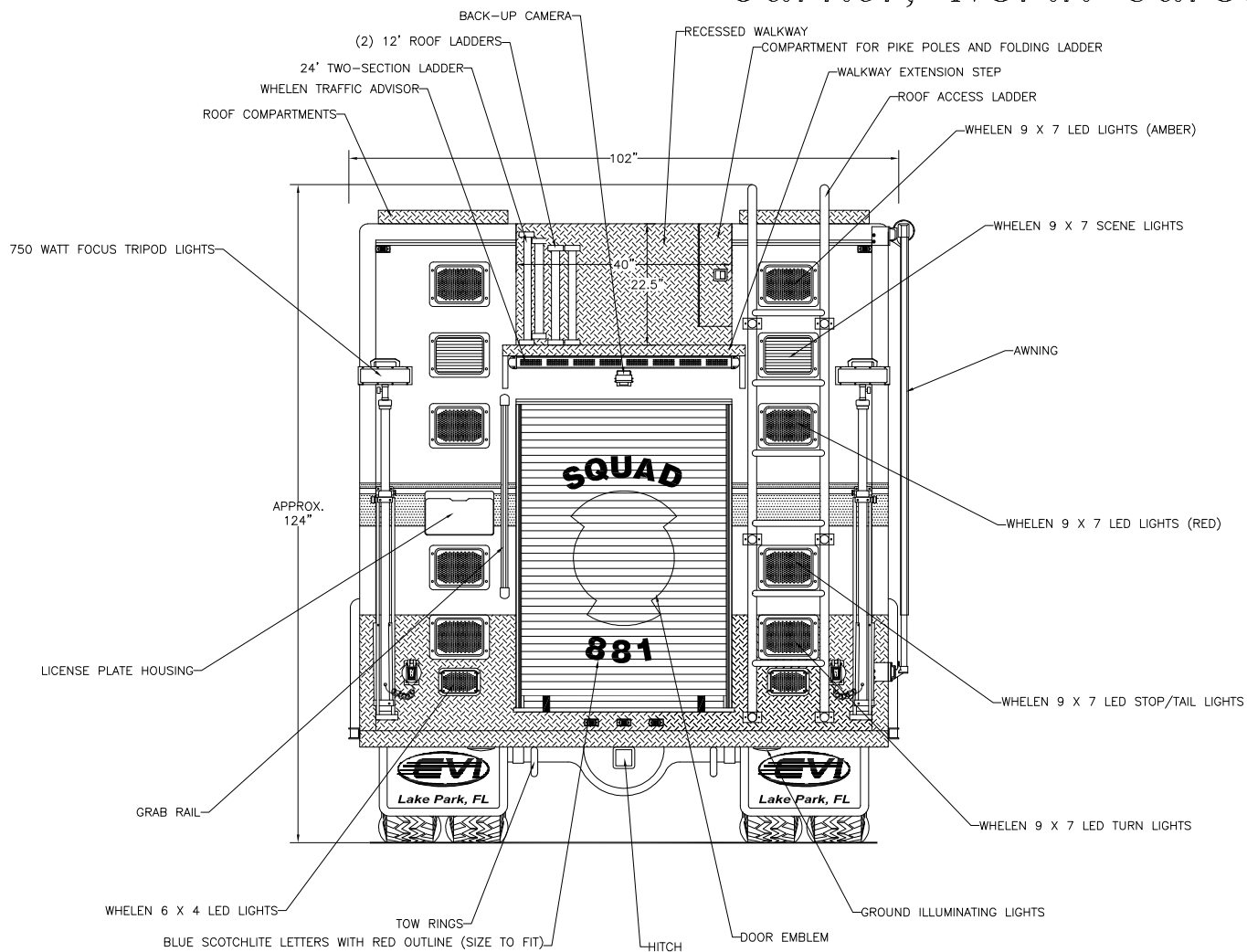

Rear View

THESE DESIGN/ENGINEERING DRAWING(S) ARE THE PROPERTY OF EMERGENCY VEHICLES, INC. THEY ARE PROPRIETARY, AND ARE FOR THE EXCLUSIVE USE OF YOUR ENTITY. ANY DIVULGING OF THIS DATA TO A THIRD PARTY IS PROHIBITED.

[Signature] DATE: 03/31/06

REVISION 1	NS - 09/12/06
REVISION 2	NS - 11/21/06
REVISION 3	-
REVISION 4	-
REVISION 5	-