

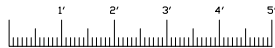

705 13TH STREET, LAKE PARK, FL
800-848-6652

*Richmond Fire Dept.
Richmond, California*

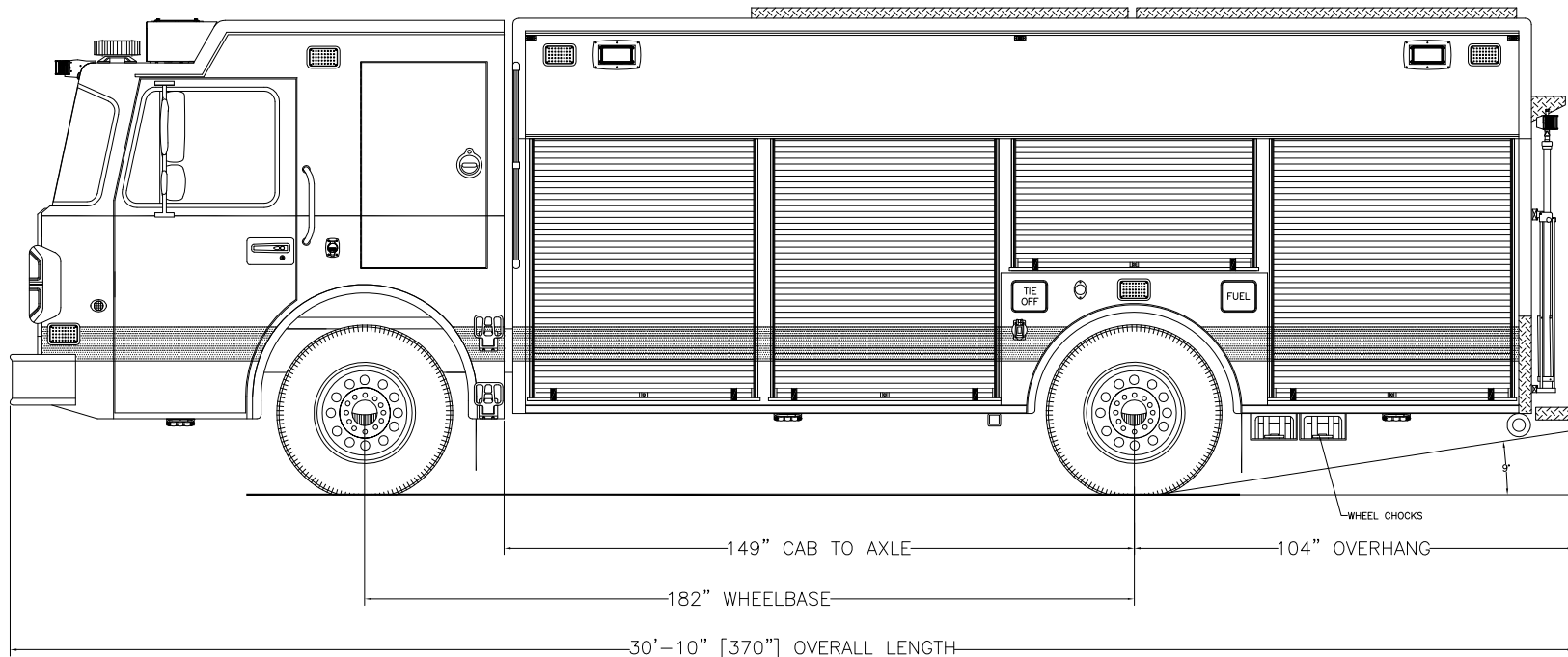

Streetside Overall

THESE DESIGN/ENGINEERING DRAWING(S) ARE THE PROPERTY OF EMERGENCY VEHICLES, INC. THEY ARE PROPRIETARY, AND ARE FOR THE EXCLUSIVE USE OF YOUR ENTITY. ANY DIVULGING OF THIS DATA TO A THIRD PARTY IS PROHIBITED.

		DATE: 01/15/14
REVISION 1	ACS	03/20/14
REVISION 2	NS	04/04/14
REVISION 3	NS	11/03/14
REVISION 4	-	-
REVISION 5	-	-



705 13TH STREET, LAKE PARK, FL
800-848-6652

Richmond Fire Dept.
Richmond, California

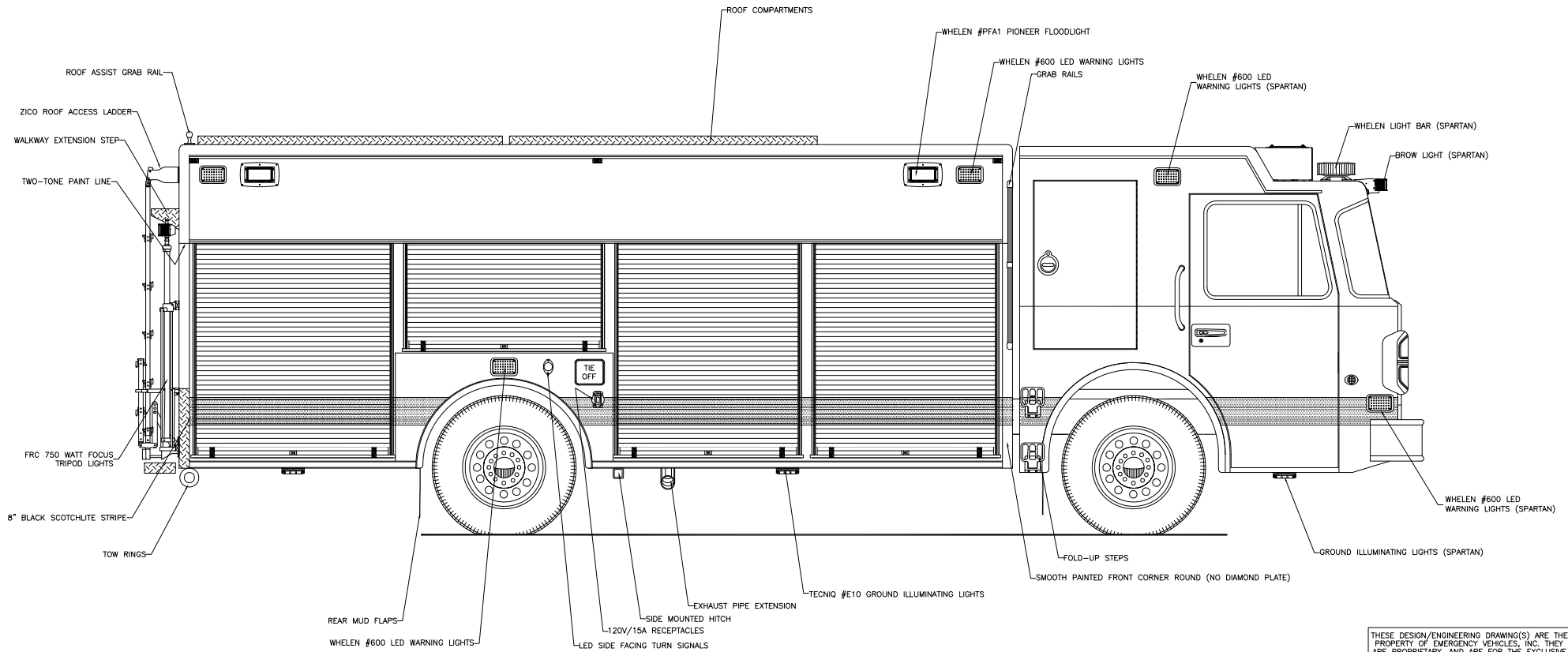

THESE DESIGN/ENGINEERING DRAWING(S) ARE THE PROPERTY OF EMERGENCY VEHICLES, INC. THEY ARE PROPRIETARY, AND ARE FOR THE EXCLUSIVE USE OF YOUR ENTITY. ANY DIVULGING OF THIS DATA TO A THIRD PARTY IS PROHIBITED.

		DATE: 01/15/14
REVISION 1	ACS	03/20/14
REVISION 2	NS	04/04/14
REVISION 3	NS	11/03/14
REVISION 4	-	-
REVISION 5	-	-

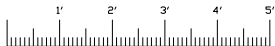

Curbside Overall



705 13TH STREET, LAKE PARK, FL
800-848-6652

*Richmond Fire Dept.
Richmond, California*

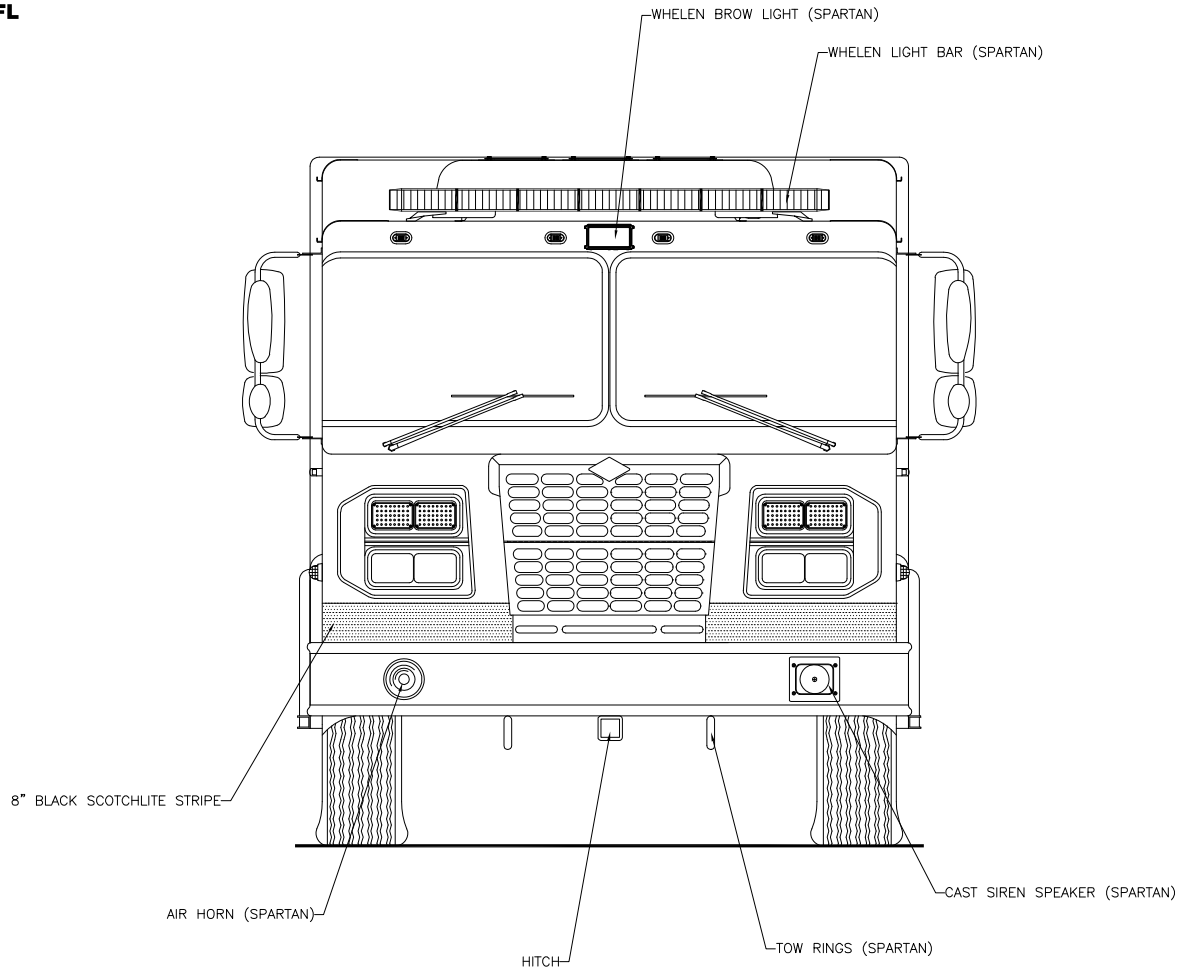

Front View

THESE DESIGN/ENGINEERING DRAWING(S) ARE THE PROPERTY OF EMERGENCY VEHICLES, INC. THEY ARE PROPRIETARY, AND ARE FOR THE EXCLUSIVE USE OF YOUR ENTITY. ANY DIVULGING OF THIS DATA TO A THIRD PARTY IS PROHIBITED.

		DATE: 01/15/14
REVISION 1	ACS	01/29/14
REVISION 2	ACS	03/20/14
REVISION 3	NS	04/04/14
REVISION 4	NS	11/03/14
REVISION 5	-	-



705 13TH STREET, LAKE PARK, FL
800-848-6652

*Richmond Fire Dept.
Richmond, California*

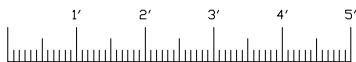
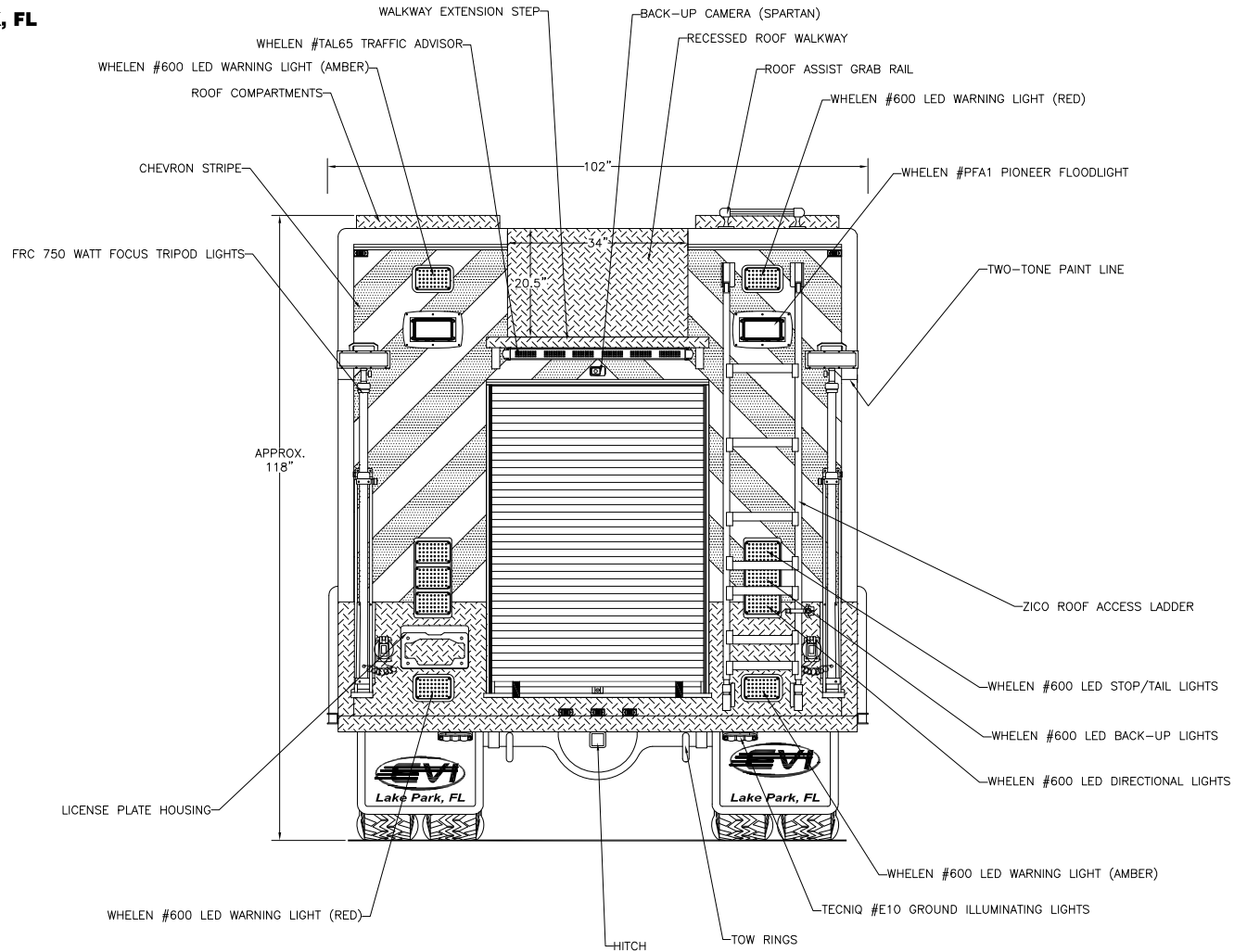

Rear View

THESE DESIGN/ENGINEERING DRAWING(S) ARE THE PROPERTY OF EMERGENCY VEHICLES, INC. THEY ARE PROPRIETARY, AND ARE FOR THE EXCLUSIVE USE OF YOUR ENTITY. ANY DIVULGING OF THIS DATA TO A THIRD PARTY IS PROHIBITED.

<i>EVI</i> DATE: 01/15/14	
REVISION 1	ACS - 03/20/14
REVISION 2	NS - 04/04/14
REVISION 3	-
REVISION 4	-
REVISION 5	-