

Cumberland County Hazmat Team Shippensburg, Pennsylvania

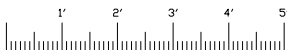
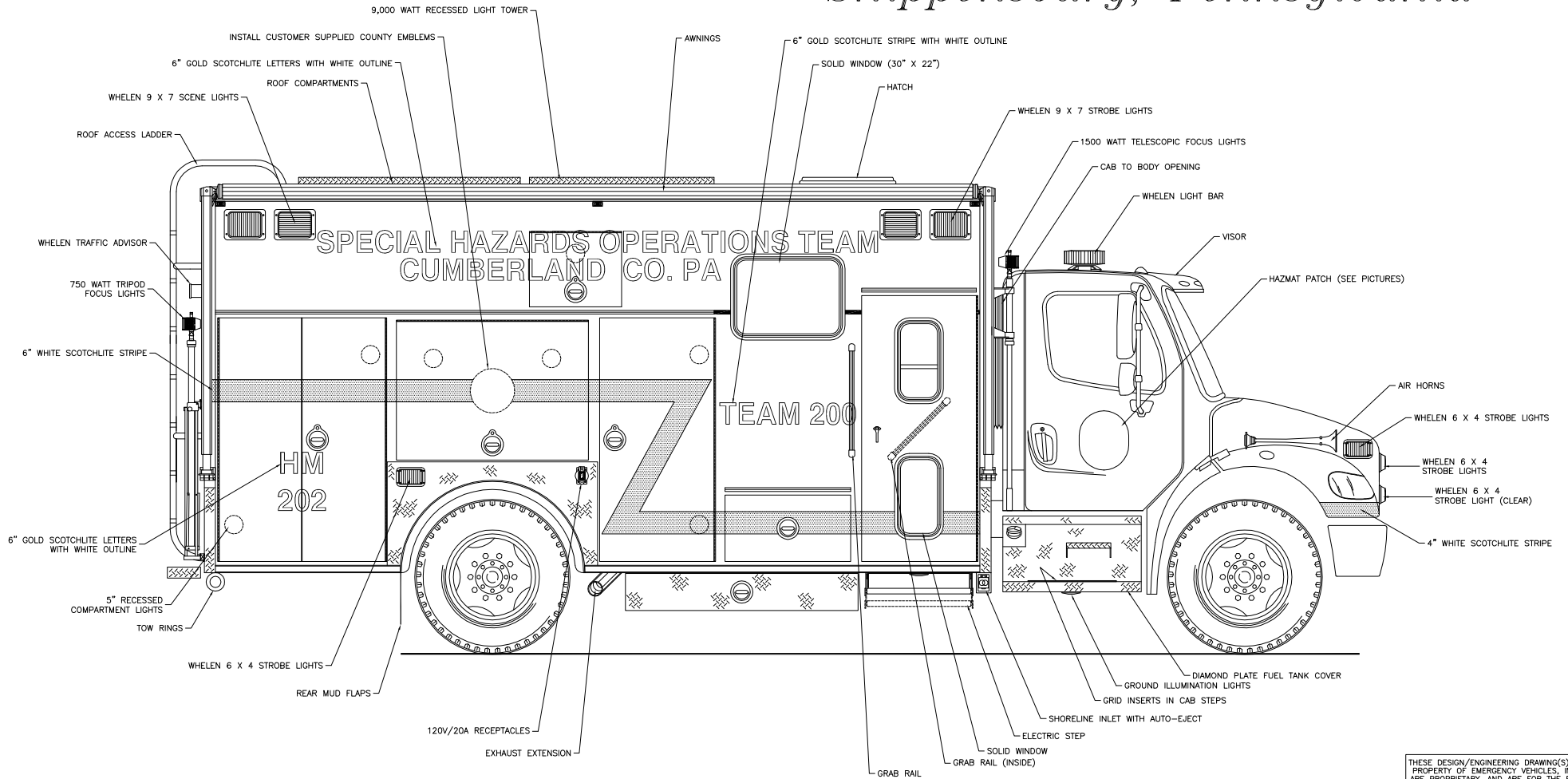

Curbside Overall

THESE DESIGN/ENGINEERING DRAWING(S) ARE THE PROPERTY OF EMERGENCY VEHICLES, INC. THEY ARE PROPRIETARY, AND ARE FOR THE EXCLUSIVE USE OF YOUR ENTITY. ANY DIVULGING OF THIS DATA TO A THIRD PARTY IS PROHIBITED.

REVISION 1	11/17/04
REVISION 2	-
REVISION 3	-
REVISION 4	-
REVISION 5	-

EMERGENCY VEHICLES, INC.

*Cumberland County Hazmat Team
Shippensburg, Pennsylvania*

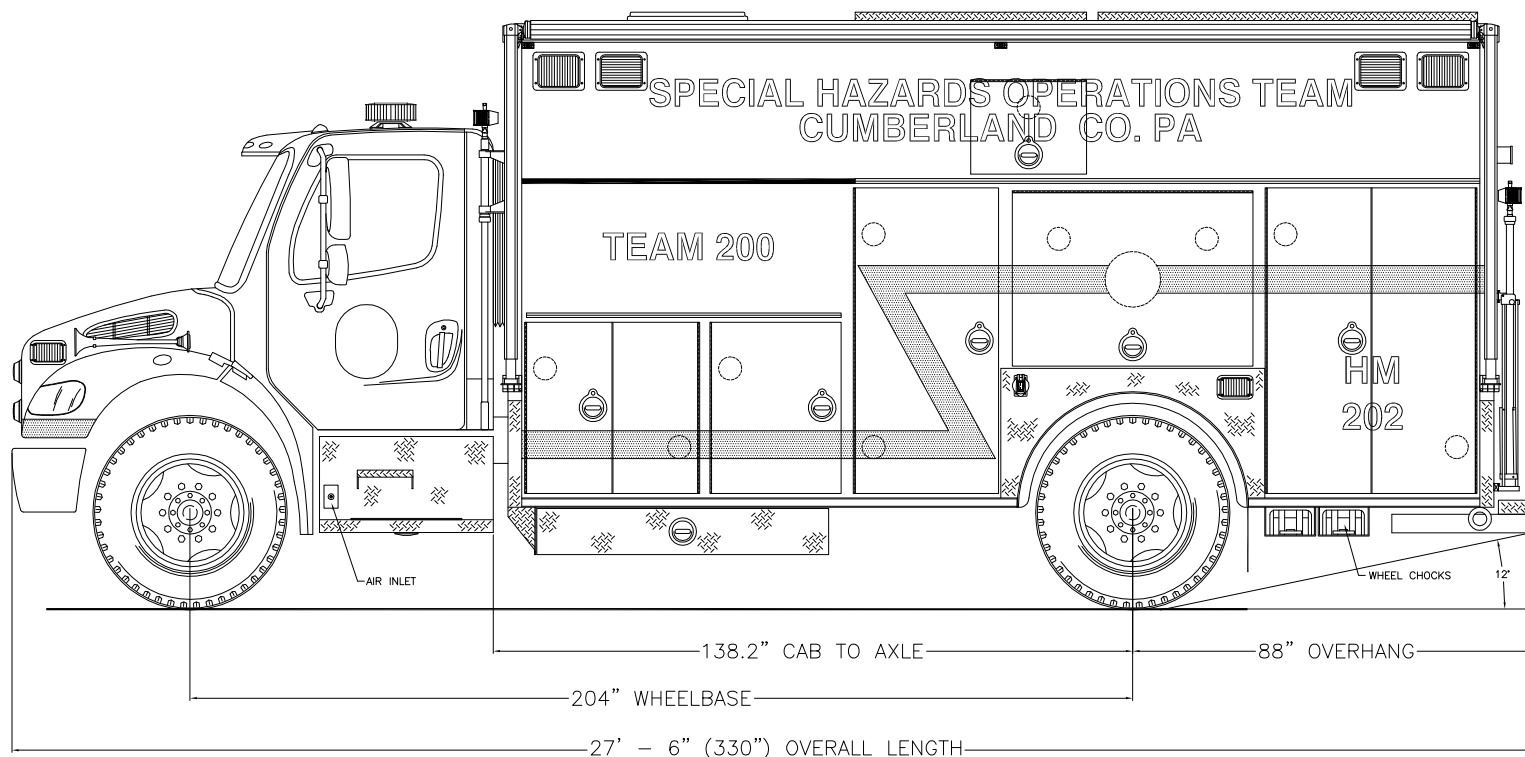

Streetside Overall

THESE DESIGN/ENGINEERING DRAWING(S) ARE THE PROPERTY OF EMERGENCY VEHICLES, INC. THEY ARE PROPRIETARY, AND ARE FOR THE EXCLUSIVE USE OF YOUR ENTITY. ANY DIVULGING OF THIS DATA TO A THIRD PARTY IS PROHIBITED.

[Signature] DATE: 01/12/04

REVISION 1	11/17/04
REVISION 2	-
REVISION 3	-
REVISION 4	-
REVISION 5	-

*Cumberland County Hazmat Team
Shippensburg, Pennsylvania*

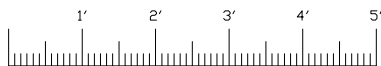
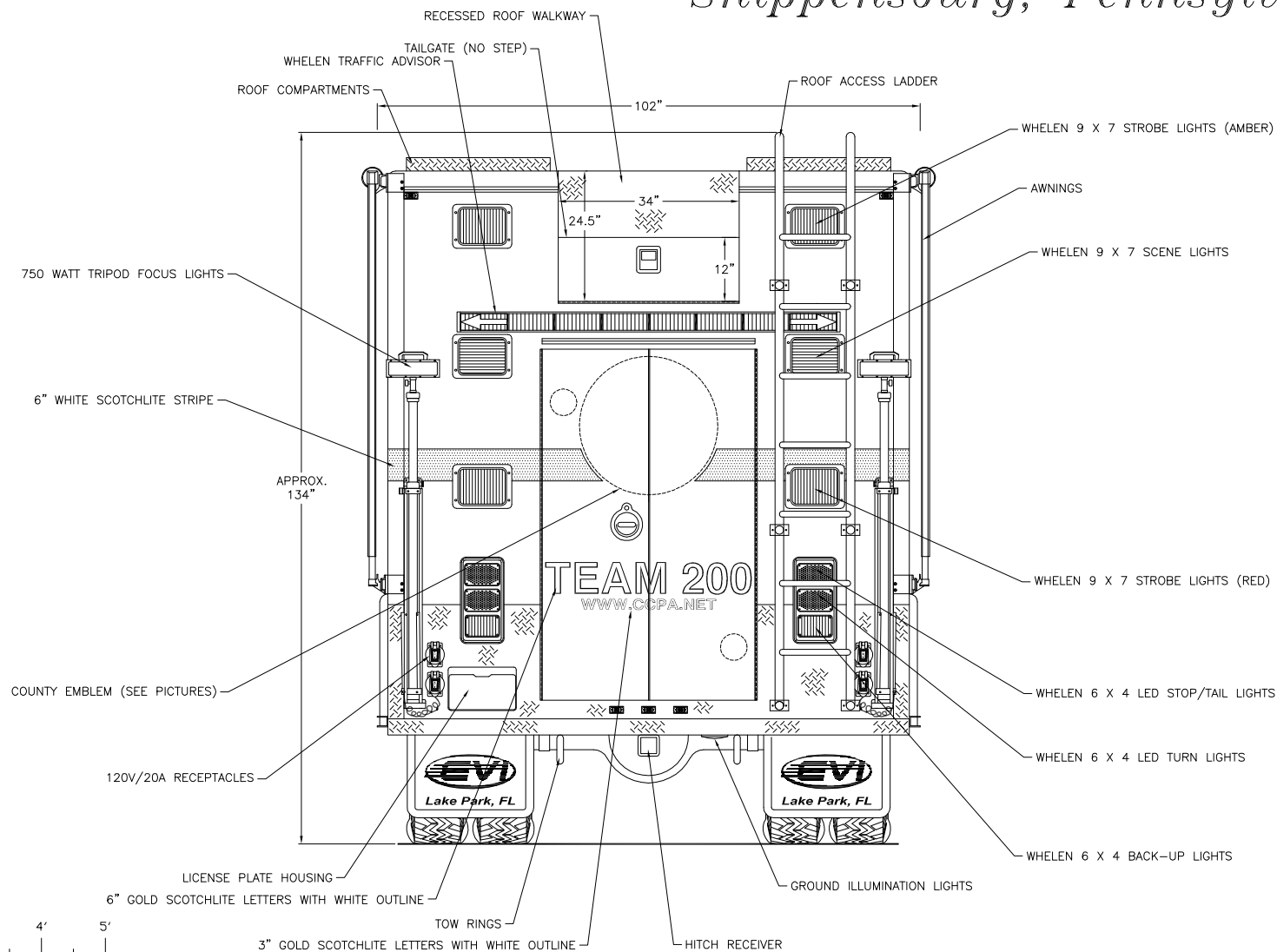

Rear View

THESE DESIGN/ENGINEERING DRAWING(S) ARE THE PROPERTY OF EMERGENCY VEHICLES, INC. THEY ARE PROPRIETARY, AND ARE FOR THE EXCLUSIVE USE OF YOUR ENTITY. ANY DIVULGING OF THIS DATA TO A THIRD PARTY IS PROHIBITED.

Design DATE: 01/12/04

REVISION 1	11/17/04
REVISION 2	-
REVISION 3	-
REVISION 4	-
REVISION 5	-

*Cumberland County Hazmat Team
Shippensburg, Pennsylvania*

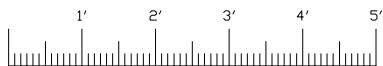
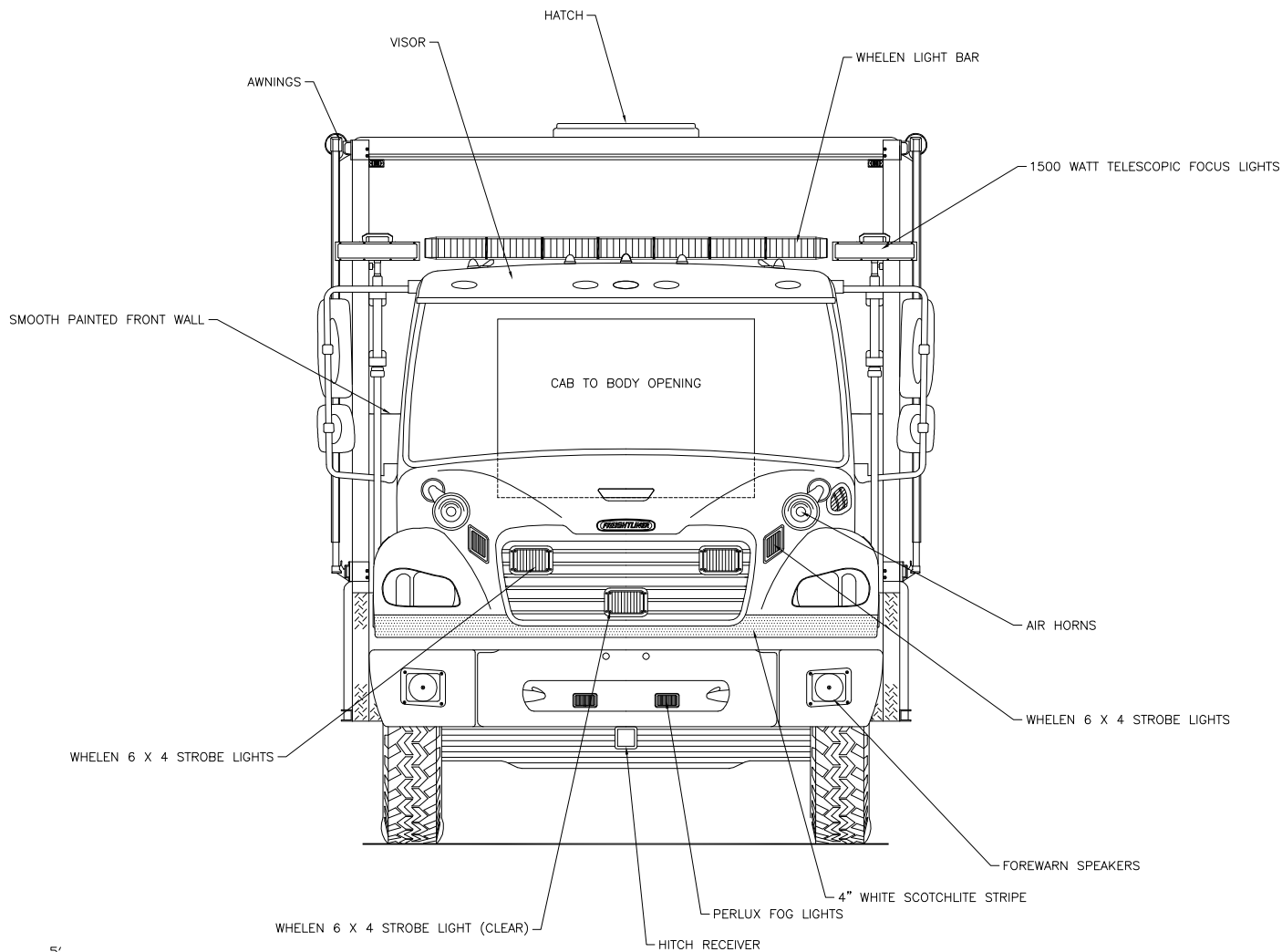

Front View

THESE DESIGN/ENGINEERING DRAWING(S) ARE THE PROPERTY OF EMERGENCY VEHICLES, INC. THEY ARE PROPRIETARY, AND ARE FOR THE EXCLUSIVE USE OF YOUR ENTITY. ANY DIVULGING OF THIS DATA TO A THIRD PARTY IS PROHIBITED.

DATE:	01/12/04
REVISION 1	11/17/04
REVISION 2	-
REVISION 3	-
REVISION 4	-
REVISION 5	-