

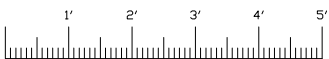

705 13TH STREET, LAKE PARK, FL  
800-848-6652

*Pooler Police Department  
Pooler, Georgia*

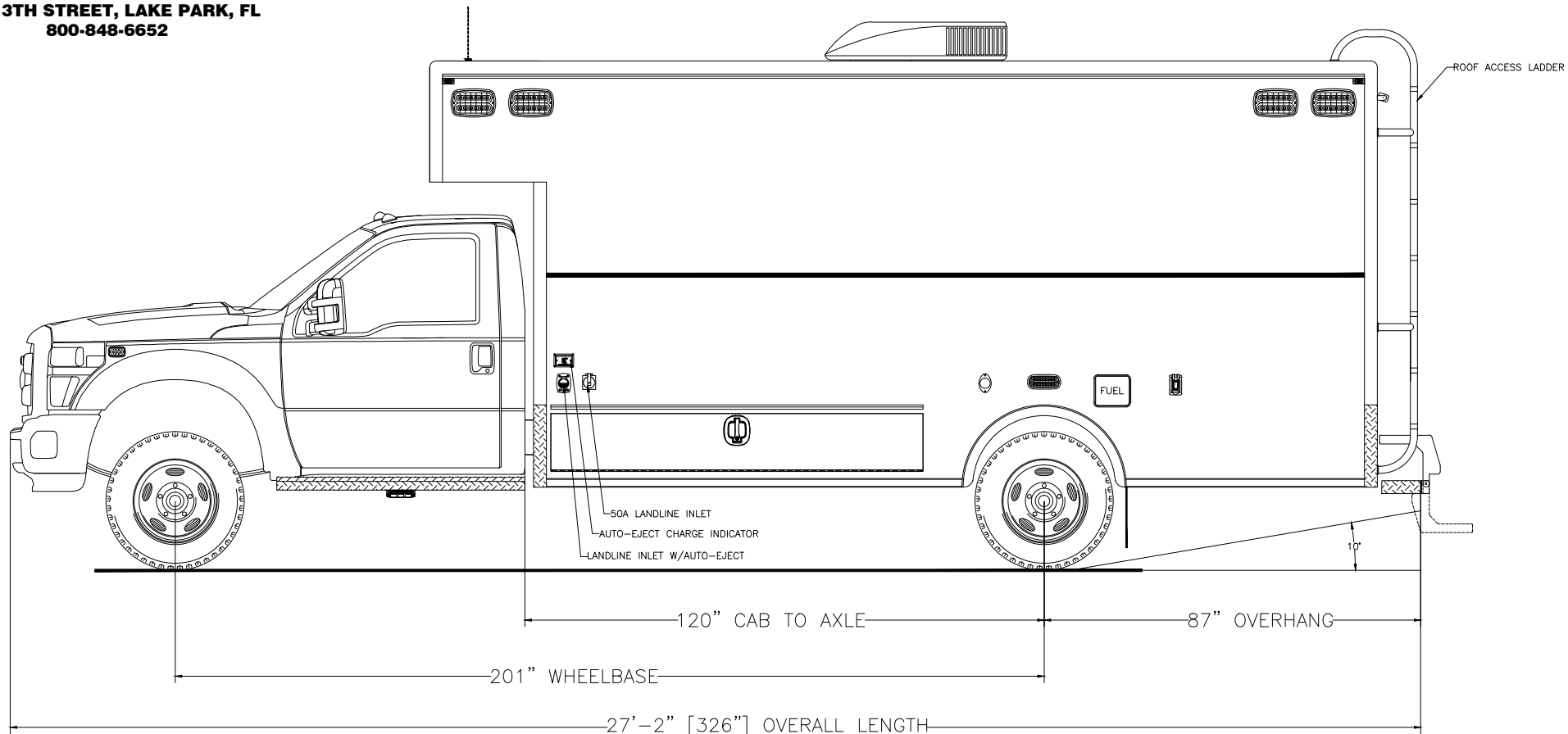

*Streetside Overall*

THESE DESIGN/ENGINEERING DRAWING(S) ARE THE PROPERTY OF EMERGENCY VEHICLES, INC. THEY ARE PROPRIETARY, AND ARE FOR THE EXCLUSIVE USE OF YOUR ENTITY. ANY DIVULGING OF THIS DATA TO A THIRD PARTY IS PROHIBITED.

		DATE: 09/29/14
REVISION 1	ACS	10/14/14
REVISION 2	NS	12/08/14
REVISION 3	LP	12/10/14
REVISION 4	-	-
REVISION 5	-	-



705 13TH STREET, LAKE PARK, FL  
800-848-6652

# Pooler Police Department Pooler, Georgia

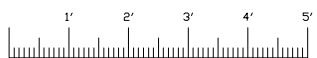
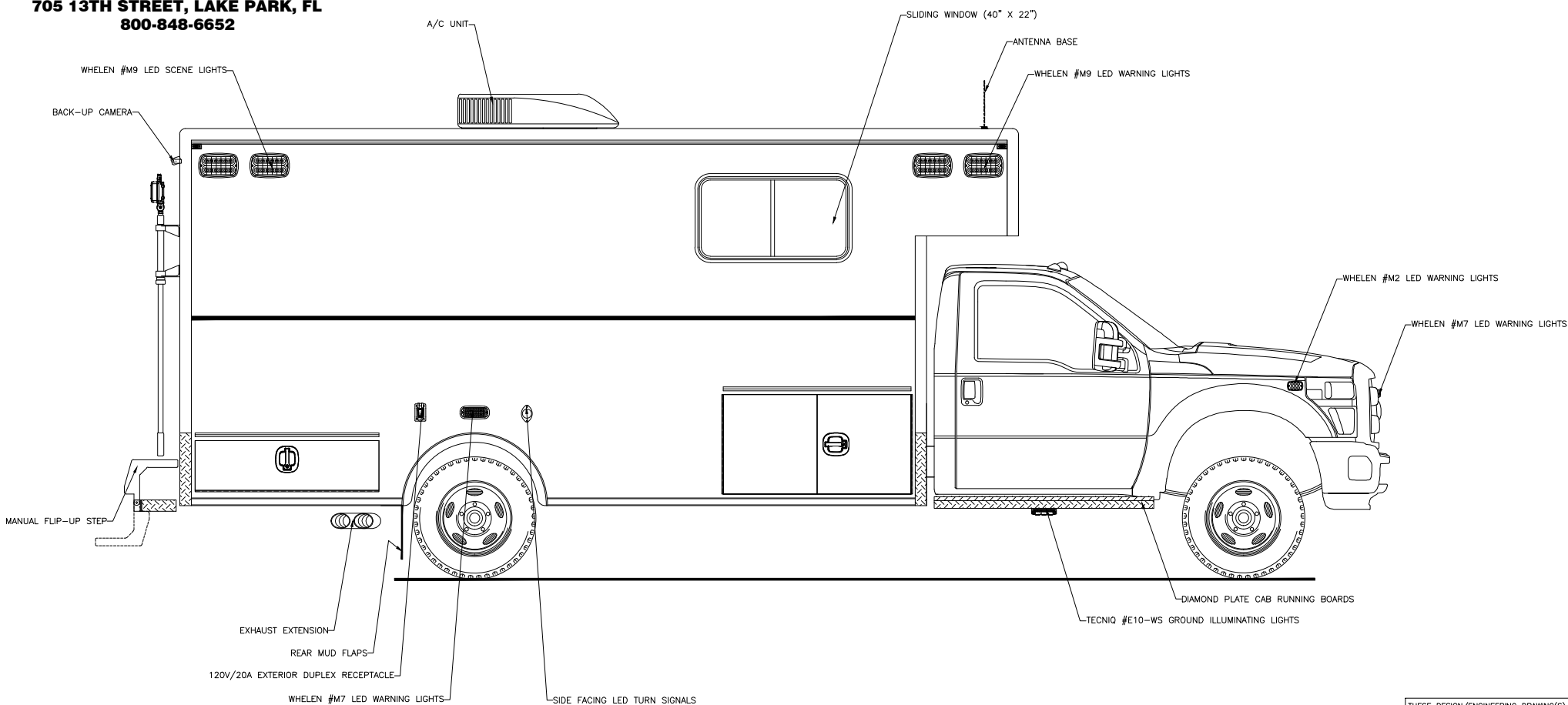

Curbside Overall

THESE DESIGN/ENGINEERING DRAWING(S) ARE THE PROPERTY OF EMERGENCY VEHICLES, INC. THEY ARE PROPRIETARY, AND ARE FOR THE EXCLUSIVE USE OF YOUR ENTITY. ANY DIVULGING OF THIS DATA TO A THIRD PARTY IS PROHIBITED.

		DATE: 09/29/14
REVISION 1	ACS	10/14/14
REVISION 2	NS	12/08/14
REVISION 3	LP	12/10/14
REVISION 4	-	-
REVISION 5	-	-



705 13TH STREET, LAKE PARK, FL  
800-848-6652

# Pooler Police Department Pooler, Georgia

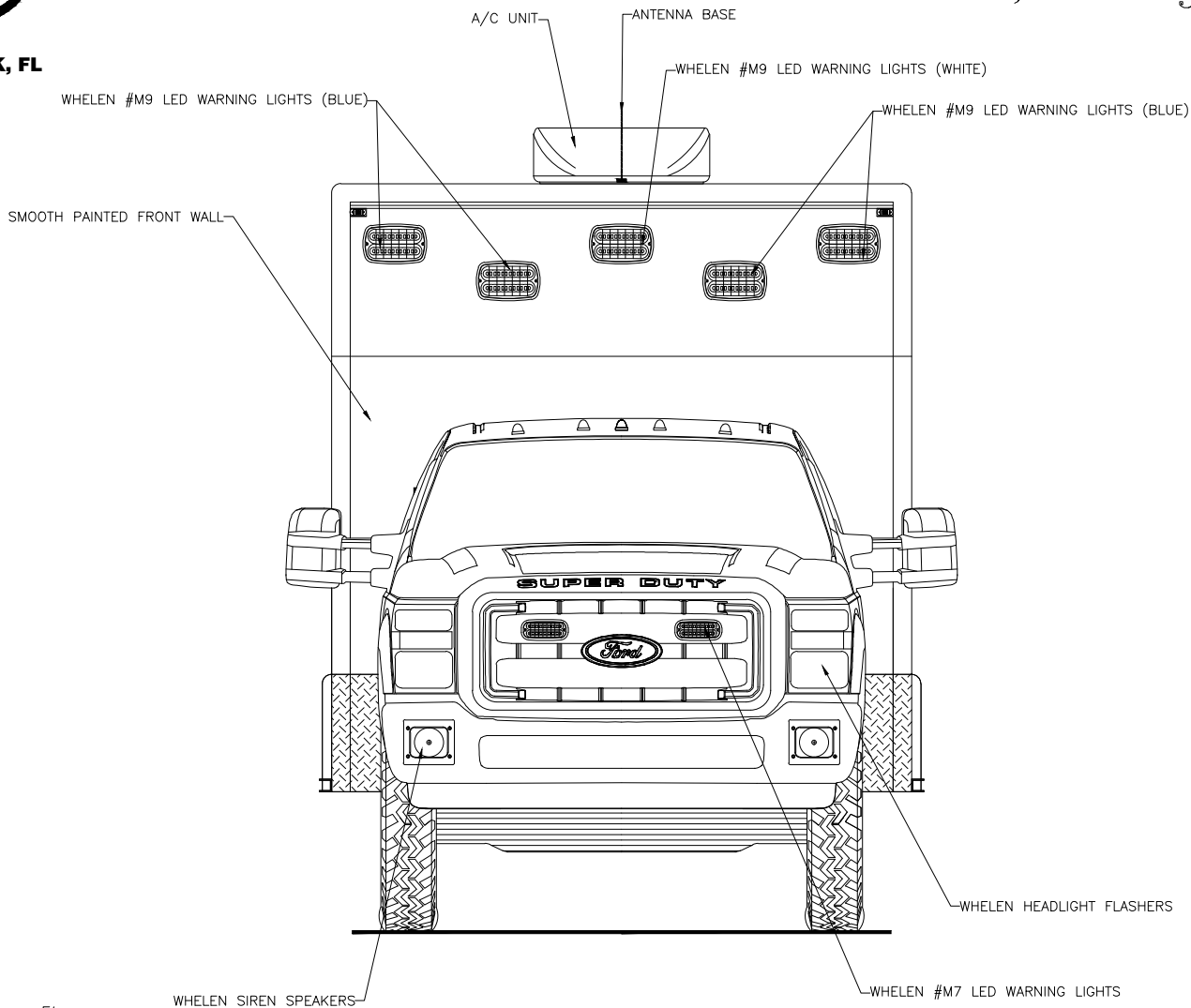

Front View

THESE DESIGN/ENGINEERING DRAWING(S) ARE THE PROPERTY OF EMERGENCY VEHICLES, INC. THEY ARE PROPRIETARY, AND ARE FOR THE EXCLUSIVE USE OF YOUR ENTITY. ANY DIVULGING OF THIS DATA TO A THIRD PARTY IS PROHIBITED.

	<i>[Signature]</i>	DATE: 09/29/14
REVISION 1	ACS	10/14/14
REVISION 2	NS	12/08/14
REVISION 3	LP	12/10/14
REVISION 4	-	-
REVISION 5	-	-



705 13TH STREET, LAKE PARK, FL  
800-848-6652

# Pooler Police Department Pooler, Georgia

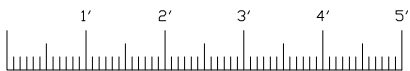
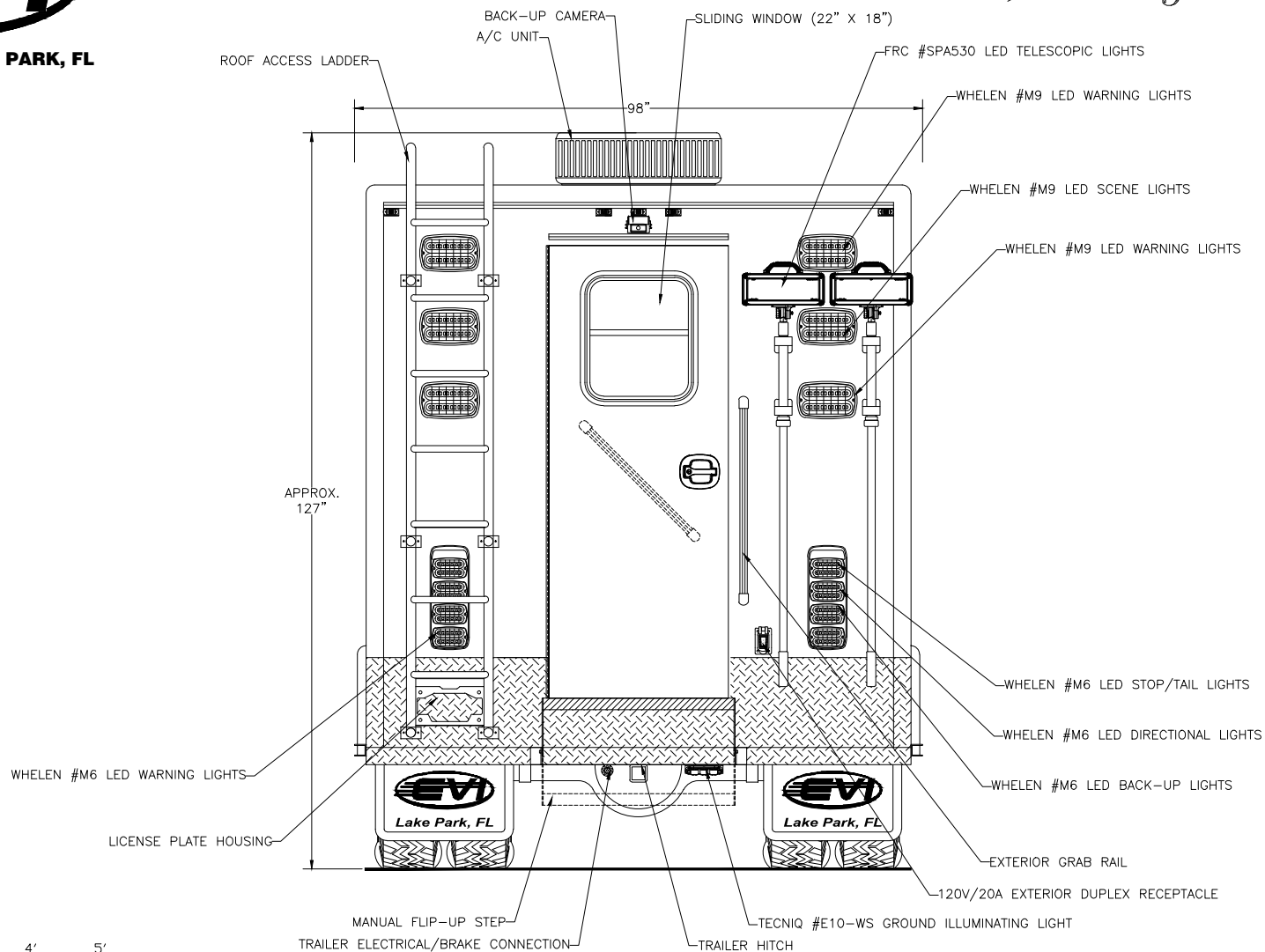

Rear View

THESE DESIGN/ENGINEERING DRAWING(S) ARE THE PROPERTY OF EMERGENCY VEHICLES, INC. THEY ARE PROPRIETARY, AND ARE FOR THE EXCLUSIVE USE OF YOUR ENTITY. ANY DIVULGING OF THIS DATA TO A THIRD PARTY IS PROHIBITED.

		DATE: 09/29/14
REVISION 1	ACS	10/14/14
REVISION 2	NS	12/08/14
REVISION 3	LP	12/10/14
REVISION 4	NS	09/03/15
REVISION 5	-	-



705 13TH STREET, LAKE PARK, FL  
800-848-6652

*Pooler Police Department  
Pooler, Georgia*

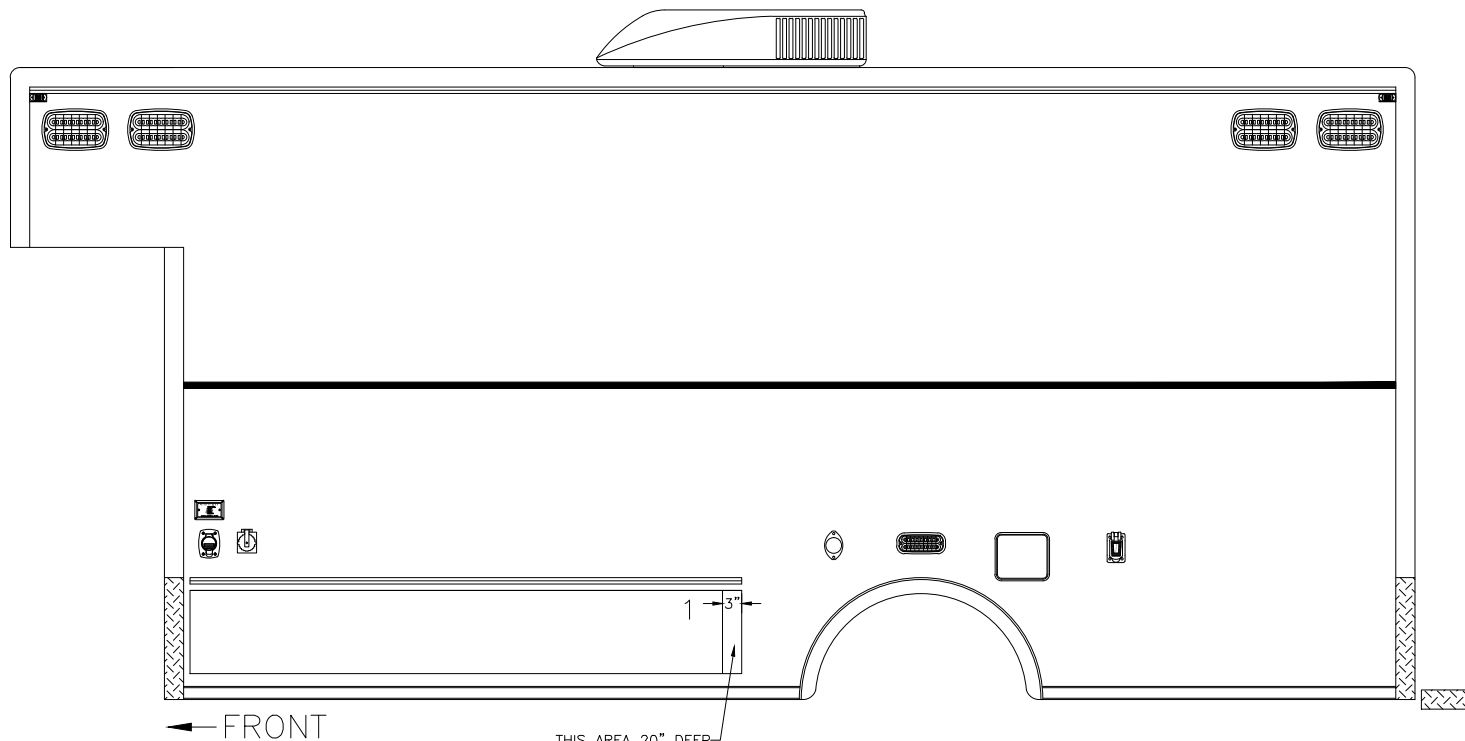

← FRONT

THIS AREA 20" DEEP

COMPARTMENT LEGEND

COMPT. #1 - 86"W X 13"H X MAX. DEPTH

THESE DESIGN/ENGINEERING DRAWING(S) ARE THE PROPERTY OF EMERGENCY VEHICLES, INC. THEY ARE PROPRIETARY, AND ARE FOR THE EXCLUSIVE USE OF YOUR ENTITY. ANY DIVULGING OF THIS DATA TO A THIRD PARTY IS PROHIBITED.

		DATE: 09/29/14
REVISION 1	ACS	10/14/14
REVISION 2	NS	12/08/14
REVISION 3	LP	12/10/14
REVISION 4	-	-
REVISION 5	-	-

*Streetside Body*



705 13TH STREET, LAKE PARK, FL  
800-848-6652

*Pooler Police Department  
Pooler, Georgia*

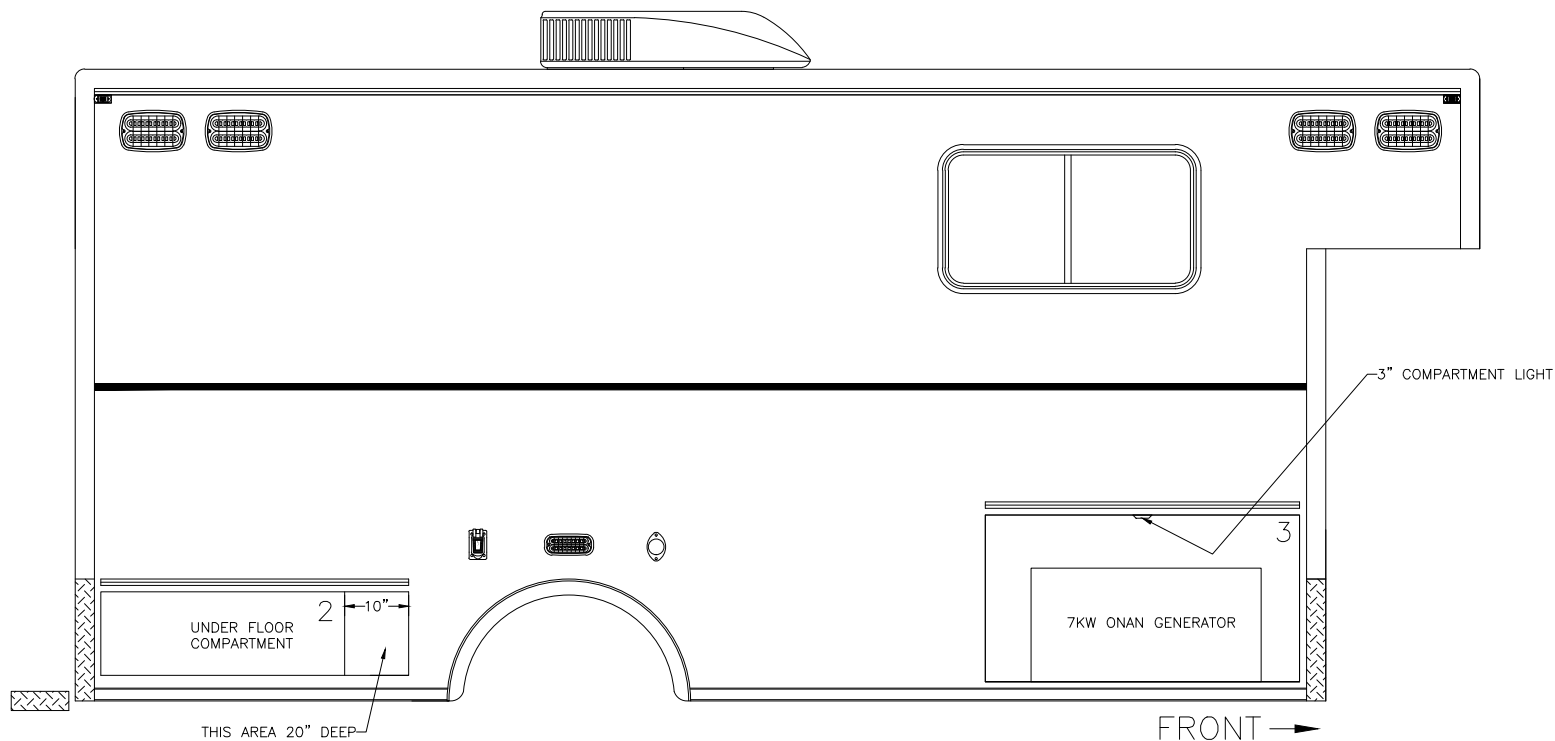

COMPARTMENT LEGEND

COMPT. #2 - 48"W X 13"H X MAX. DEPTH  
COMPT. #3 - 49"W X 26"H X MAX. DEPTH

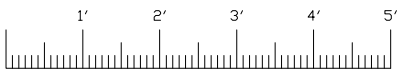

*Curbside Body*

THESE DESIGN/ENGINEERING DRAWING(S) ARE THE PROPERTY OF EMERGENCY VEHICLES, INC. THEY ARE PROPRIETARY, AND ARE FOR THE EXCLUSIVE USE OF YOUR ENTITY. ANY DIVULGING OF THIS DATA TO A THIRD PARTY IS PROHIBITED.

		DATE: 09/29/14
REVISION 1	ACS	10/14/14
REVISION 2	NS	12/08/14
REVISION 3	LP	12/10/14
REVISION 4	-	-
REVISION 5	-	-



705 13TH STREET, LAKE PARK, FL  
800-848-6652

# Pooler Police Department Pooler, Georgia

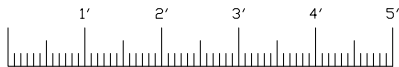
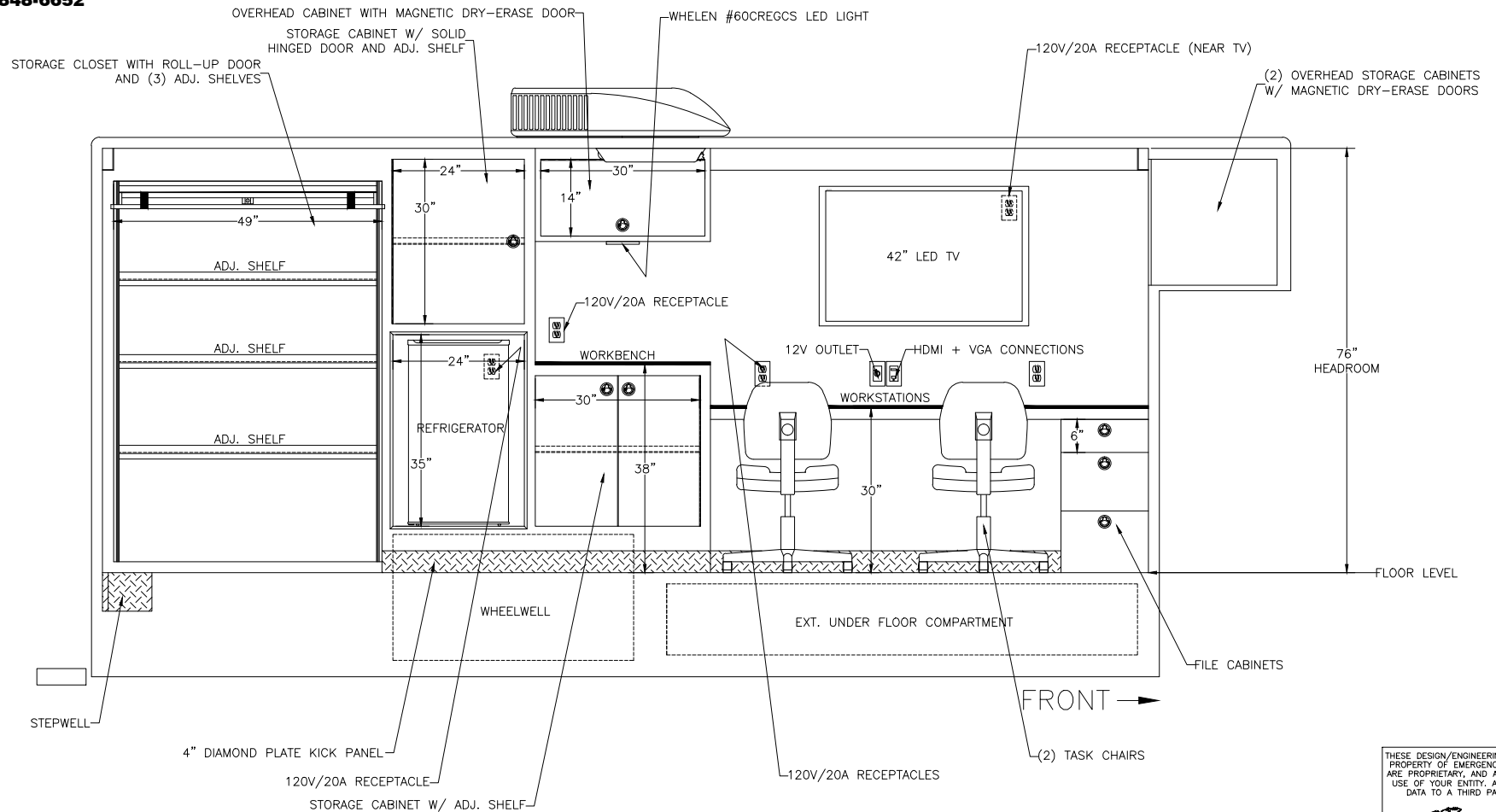

## Streetside Interior

THESE DESIGN/ENGINEERING DRAWING(S) ARE THE PROPERTY OF EMERGENCY VEHICLES, INC. THEY ARE PROPRIETARY, AND ARE FOR THE EXCLUSIVE USE OF YOUR ENTITY. ANY DIVULGING OF THIS DATA TO A THIRD PARTY IS PROHIBITED.

REVISION 1	ACS - 10/14/14
REVISION 2	NS - 12/08/14
REVISION 3	LP - 12/10/14
REVISION 4	-
REVISION 5	-



705 13TH STREET, LAKE PARK, FL  
800-848-6652

# Pooler Police Department Pooler, Georgia

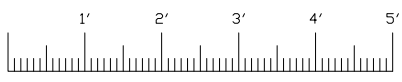
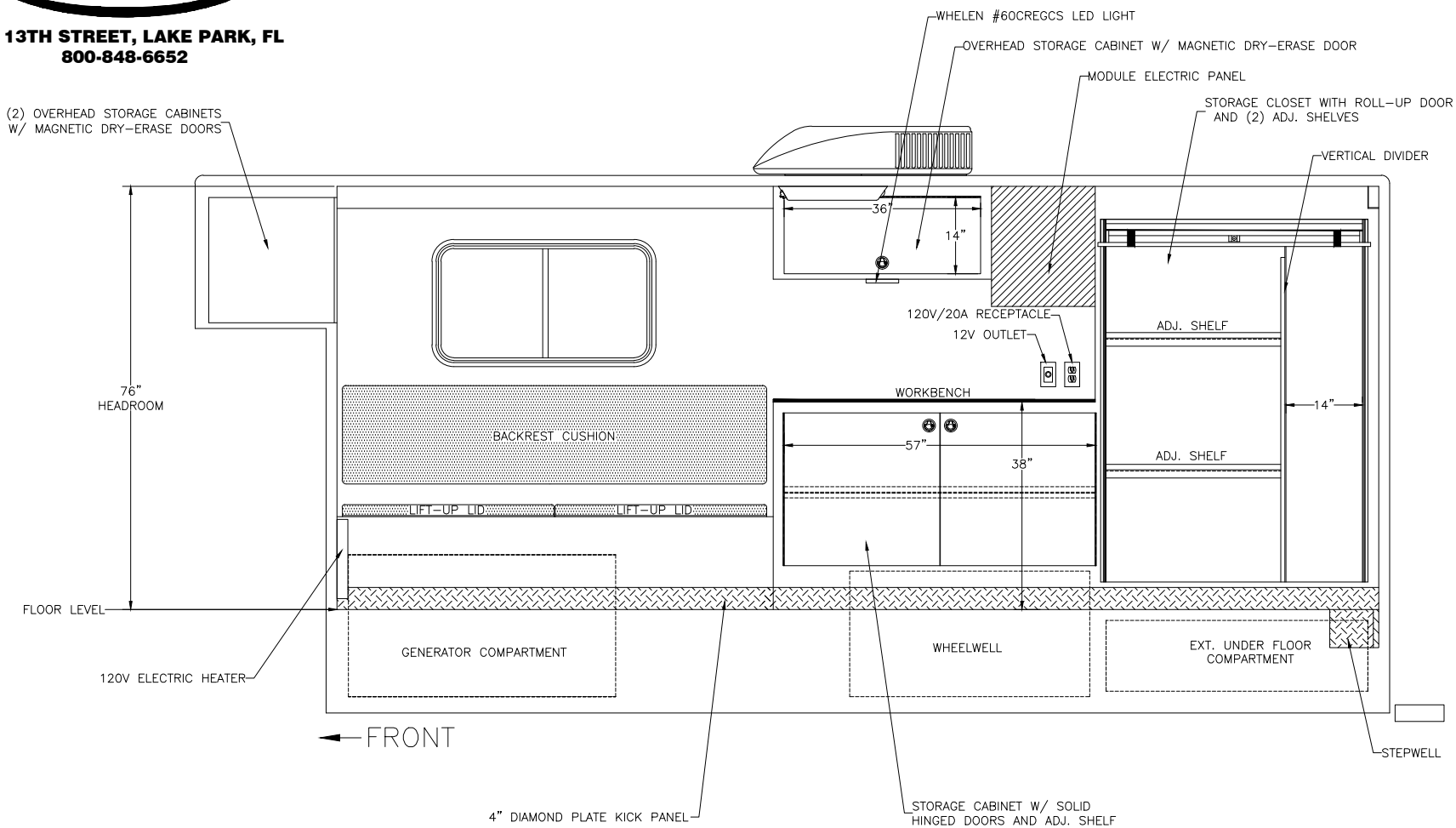

## Curbside Interior

THESE DESIGN/ENGINEERING DRAWING(S) ARE THE PROPERTY OF EMERGENCY VEHICLES, INC. THEY ARE PROPRIETARY, AND ARE FOR THE EXCLUSIVE USE OF YOUR ENTITY. ANY DIVULGING OF THIS DATA TO A THIRD PARTY IS PROHIBITED.

*[Signature]* DATE: 09/29/14

REVISION 1	ACS - 10/14/14
REVISION 2	NS - 12/08/14
REVISION 3	-
REVISION 4	-
REVISION 5	-





705 13TH STREET, LAKE PARK, FL  
800-848-6652

# Pooler Police Department Pooler, Georgia

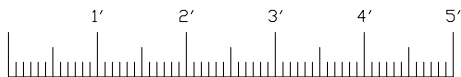
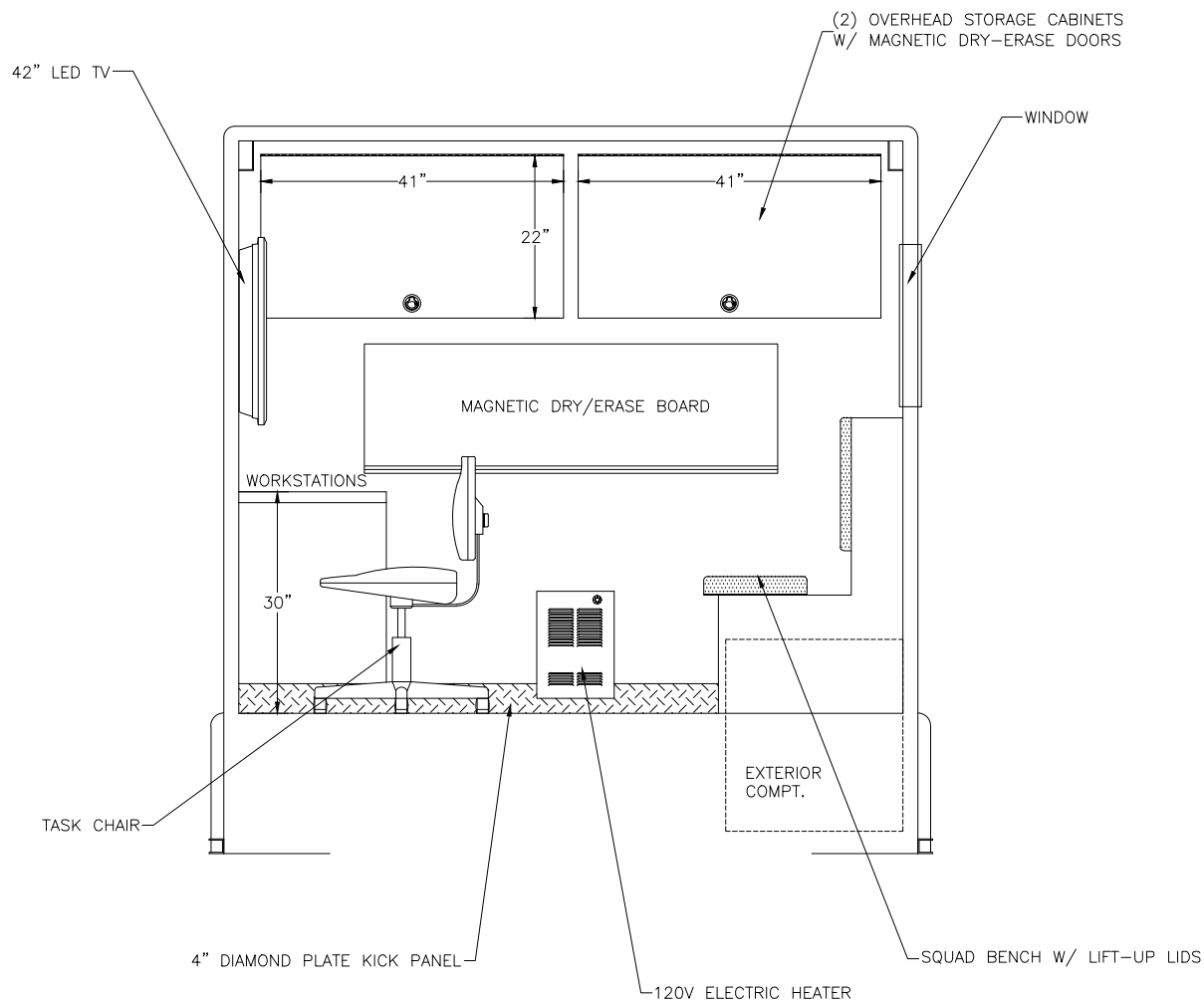

Front Interior View

THESE DESIGN/ENGINEERING DRAWING(S) ARE THE PROPERTY OF EMERGENCY VEHICLES, INC. THEY ARE PROPRIETARY, AND ARE FOR THE EXCLUSIVE USE OF YOUR ENTITY. ANY DIVULGING OF THIS DATA TO A THIRD PARTY IS PROHIBITED.

		DATE: 09/29/14
REVISION 1	ACS	10/14/14
REVISION 2	NS	12/08/14
REVISION 3	LP	12/10/14
REVISION 4	-	-
REVISION 5	-	-



705 13TH STREET, LAKE PARK, FL  
800-848-6652

# Pooler Police Department Pooler, Georgia

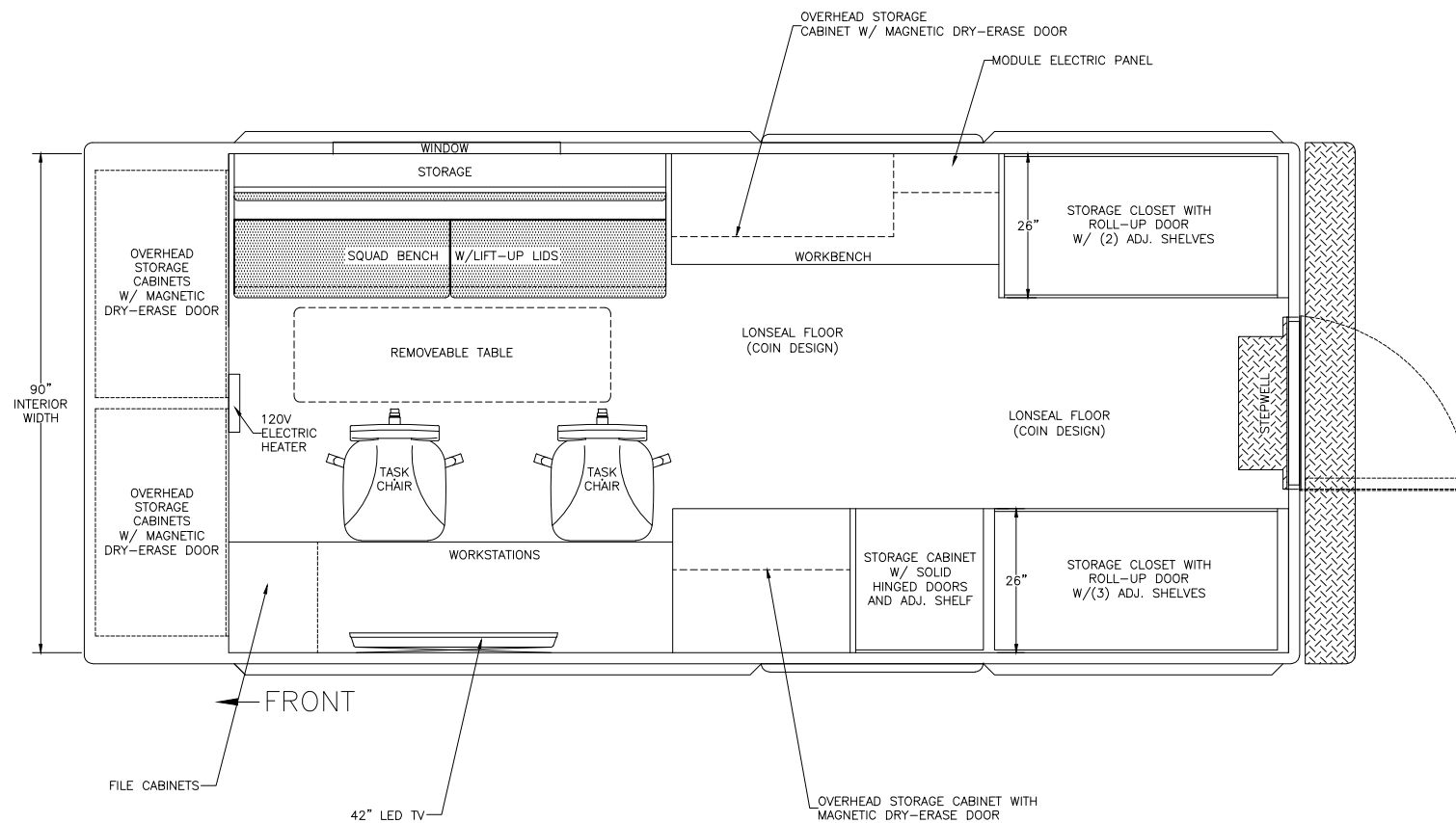

## Body Planview

THESE DESIGN/ENGINEERING DRAWING(S) ARE THE PROPERTY OF EMERGENCY VEHICLES, INC. THEY ARE PROPRIETARY, AND ARE FOR THE EXCLUSIVE USE OF YOUR ENTITY. ANY DIVULGING OF THIS DATA TO A THIRD PARTY IS PROHIBITED.

		DATE: 09/29/14
REVISION 1	ACS	10/14/14
REVISION 2	NS	12/08/14
REVISION 3	LP	12/10/14
REVISION 4	-	-
REVISION 5	-	-