

EMERGENCY VEHICLES, INC.

*Powersville Fire Department
Piedmont, South Carolina*

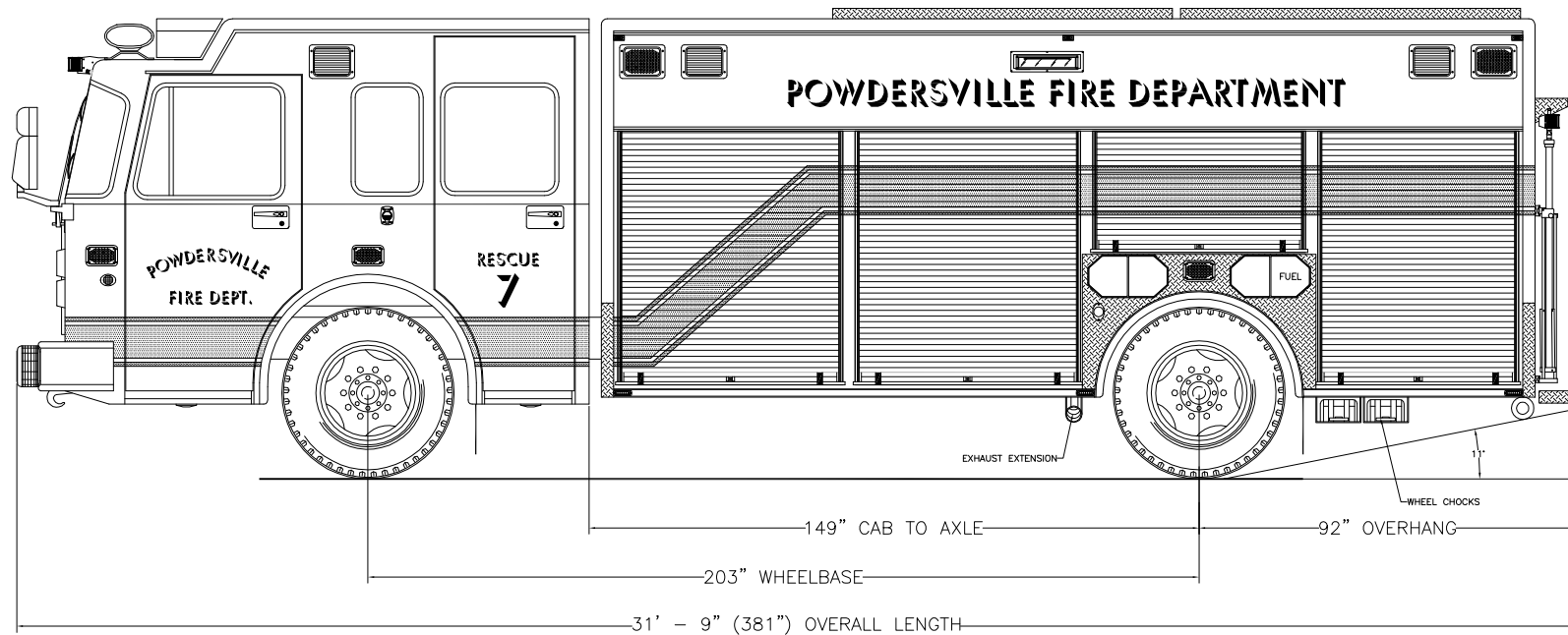

THESE DESIGN/ENGINEERING DRAWING(S) ARE THE PROPERTY OF EMERGENCY VEHICLES, INC. THEY ARE PROPRIETARY, AND ARE FOR THE EXCLUSIVE USE OF YOUR ENTITY. ANY DIVULGING OF THIS DATA TO A THIRD PARTY IS PROHIBITED.

EJ Powell DATE: 07/6/09

REVISION 1	NS - 07/13/09
REVISION 2	-
REVISION 3	-
REVISION 4	-
REVISION 5	-

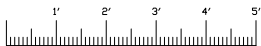

Streetside Overall

*Powersville Fire Department
Piedmont, South Carolina*

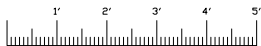
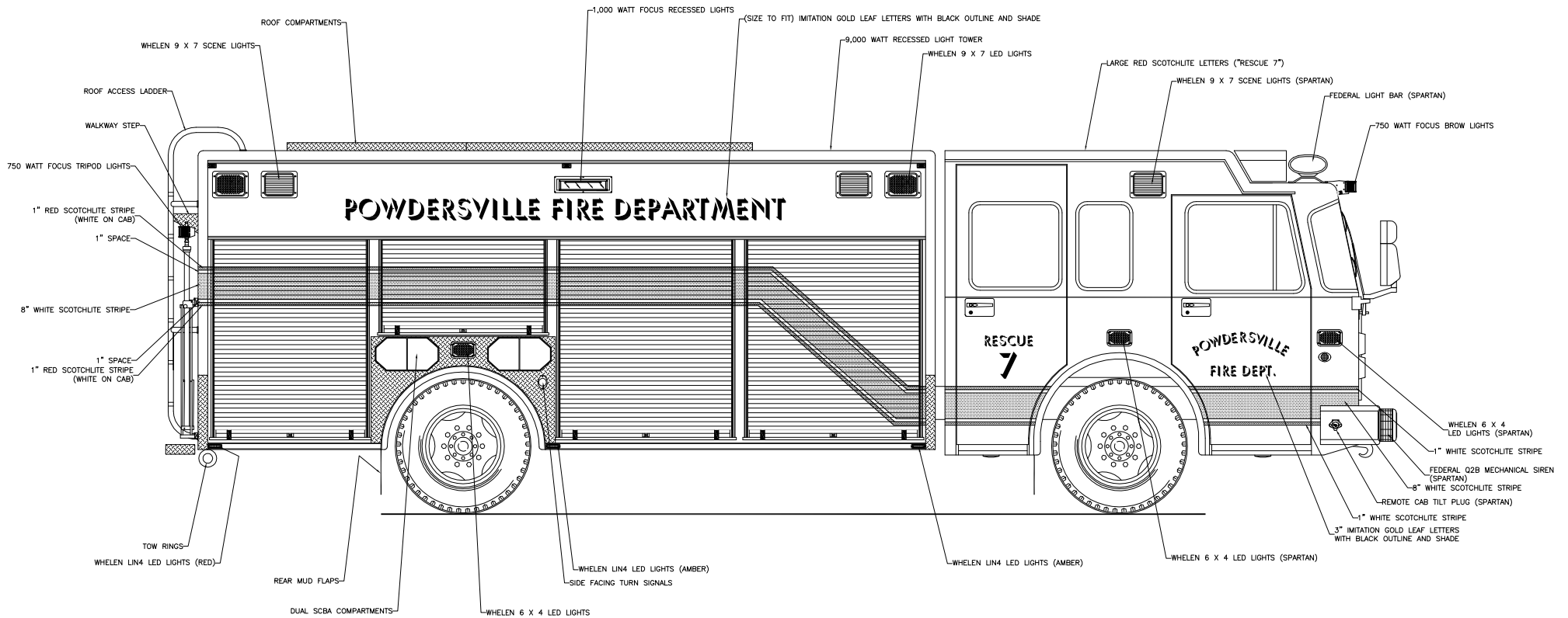

Curbside Overall

THESE DESIGN/ENGINEERING DRAWING(S) ARE THE PROPERTY OF EMERGENCY VEHICLES, INC. THEY ARE PROPRIETARY, AND ARE FOR THE EXCLUSIVE USE OF YOUR ENTITY. ANY DIVULGING OF THIS DATA TO A THIRD PARTY IS PROHIBITED.

<i>E. J. Pinner</i>		DATE: 07/06/09
REVISION 1	NS	07/13/09
REVISION 2	-	-
REVISION 3	-	-
REVISION 4	-	-
REVISION 5	-	-

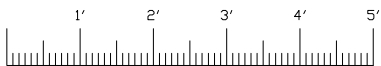
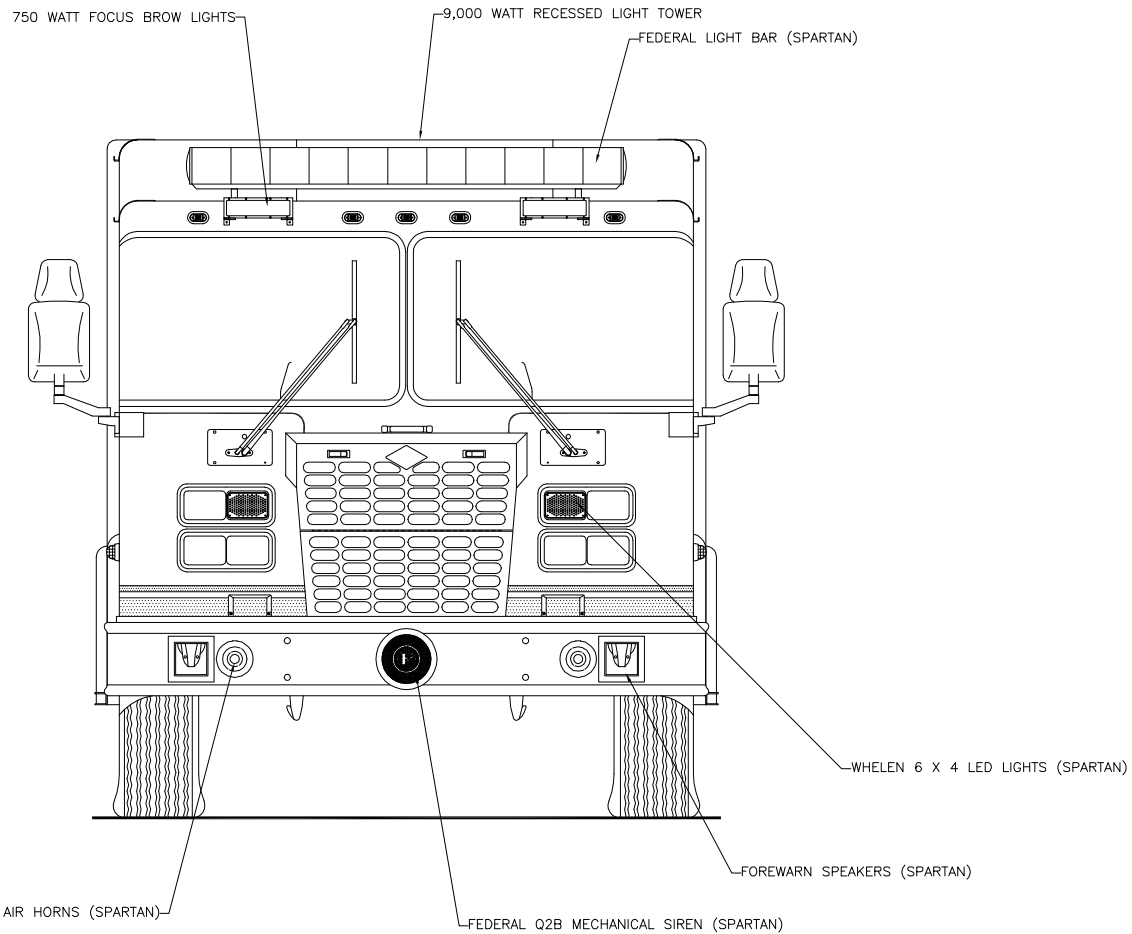

Front View

THESE DESIGN/ENGINEERING DRAWING(S) ARE THE PROPERTY OF EMERGENCY VEHICLES, INC. THEY ARE PROPRIETARY, AND ARE FOR THE EXCLUSIVE USE OF YOUR ENTITY. ANY DIVULGING OF THIS DATA TO A THIRD PARTY IS PROHIBITED.

<i>E. J. Powers</i>		DATE: 07/06/09
REVISION 1	NS	07/13/09
REVISION 2	-	-
REVISION 3	-	-
REVISION 4	-	-
REVISION 5	-	-

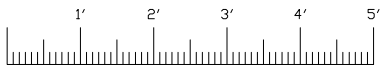
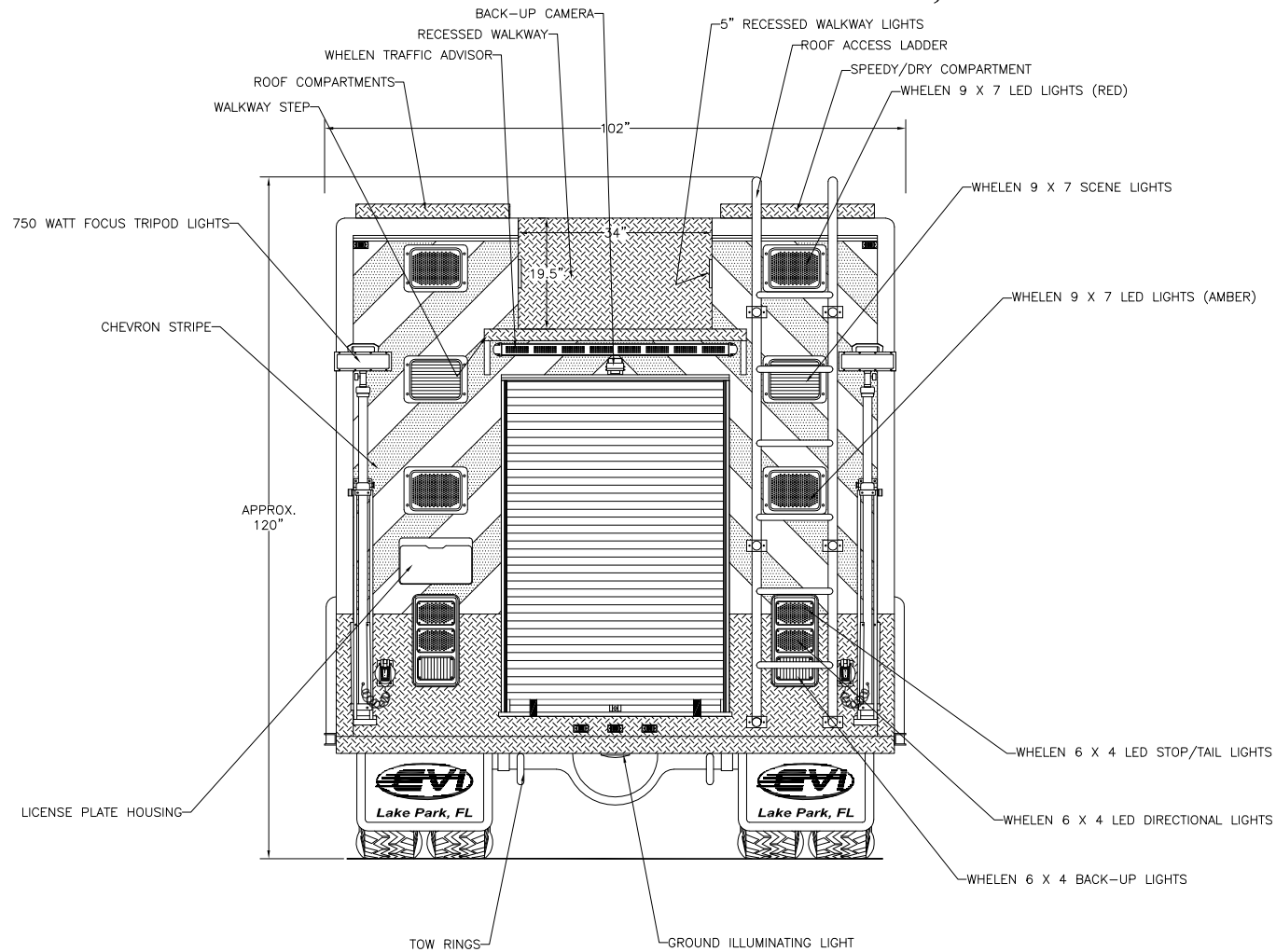

Rear View

THESE DESIGN/ENGINEERING DRAWING(S) ARE THE PROPERTY OF EMERGENCY VEHICLES, INC. THEY ARE PROPRIETARY, AND ARE FOR THE EXCLUSIVE USE OF YOUR ENTITY. ANY DIVULGING OF THIS DATA TO A THIRD PARTY IS PROHIBITED.

<i>E.V. Inc.</i>		DATE: 07/06/09
REVISION 1	NS	07/13/09
REVISION 2	NS	12/14/09
REVISION 3	-	-
REVISION 4	-	-
REVISION 5	-	-