

NOTE: STRIPE ON PAINTED SURFACES - WHITE
 STRIPE ON S.S. AND ANODIZED SURFACES - RED/WHITE/RED

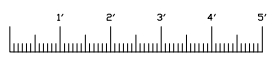

Curbside Overall

THESE DESIGN/ENGINEERING DRAWING(S) ARE THE PROPERTY OF EMERGENCY VEHICLES, INC. THEY ARE PROPRIETARY, AND ARE FOR THE EXCLUSIVE USE OF YOUR ENTITY. ANY DIVULGING OF THIS DATA TO A THIRD PARTY IS PROHIBITED.

[Signature] DATE: 08/30/05

REVISION 1	NS - 04/11/06
REVISION 2	-
REVISION 3	-
REVISION 4	-
REVISION 5	-

EMERGENCY VEHICLES, INC.

*E.M. Holt Fire Department
Burlington, North Carolina*

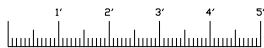
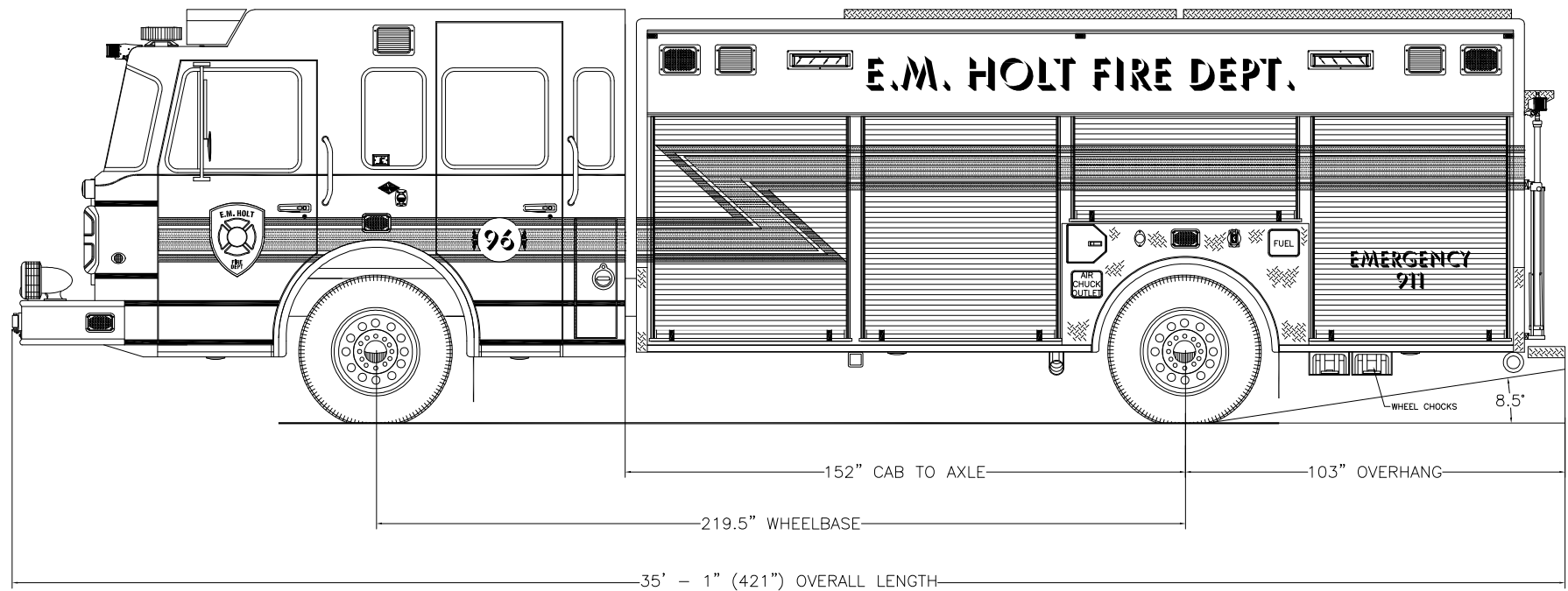

Streetside Overall

THESE DESIGN/ENGINEERING DRAWING(S) ARE THE PROPERTY OF EMERGENCY VEHICLES, INC. THEY ARE PROPRIETARY, AND ARE FOR THE EXCLUSIVE USE OF YOUR ENTITY. ANY DIVULGING OF THIS DATA TO A THIRD PARTY IS PROHIBITED.

[Signature] DATE: 08/30/05

REVISION 1	NS - 04/11/06
REVISION 2	-
REVISION 3	-
REVISION 4	-
REVISION 5	-

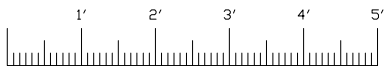
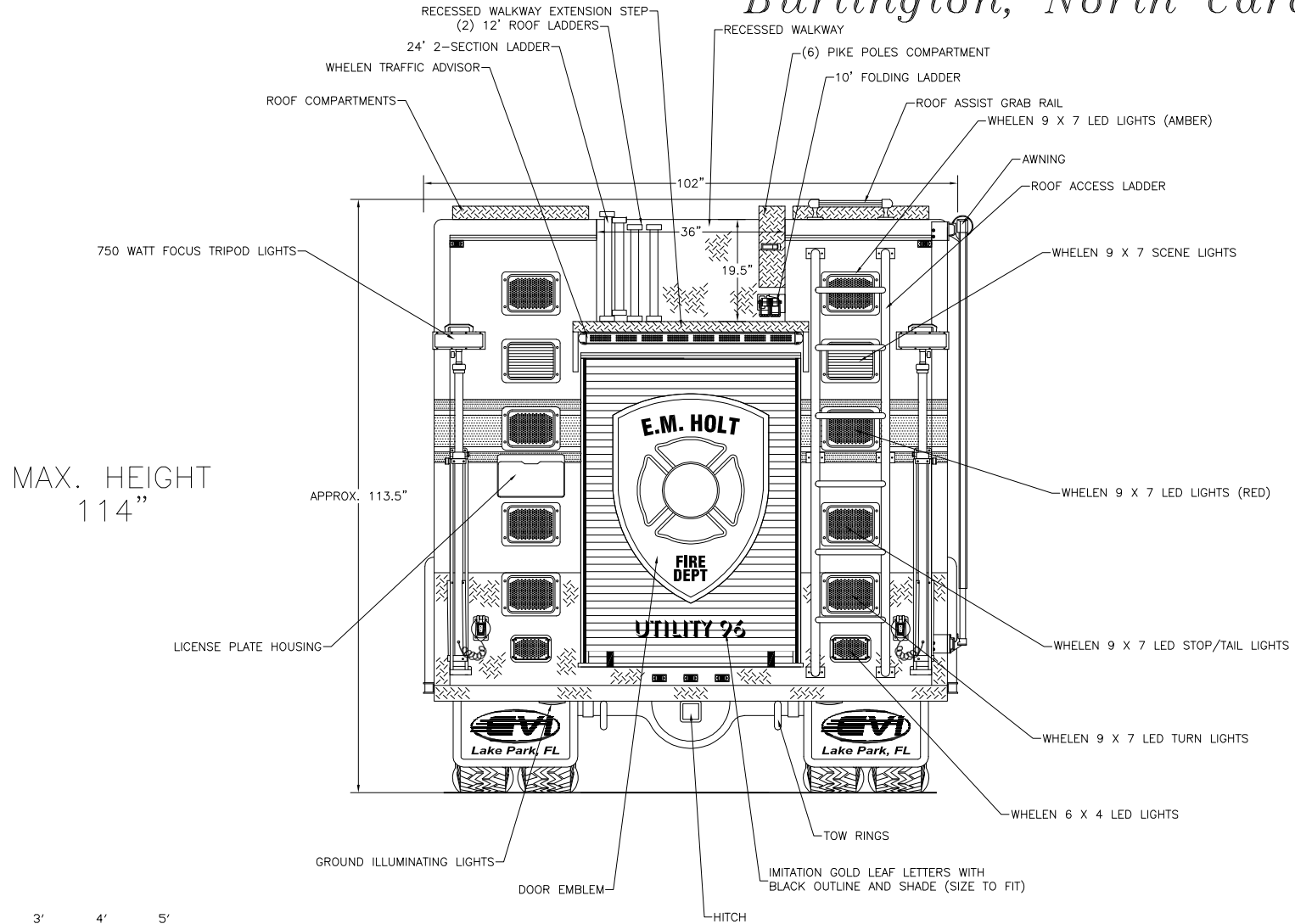

Rear View

THESE DESIGN/ENGINEERING DRAWING(S) ARE THE PROPERTY OF EMERGENCY VEHICLES, INC. THEY ARE PROPRIETARY, AND ARE FOR THE EXCLUSIVE USE OF YOUR ENTITY. ANY DIVULGING OF THIS DATA TO A THIRD PARTY IS PROHIBITED.

[Signature] DATE: 08/30/05

REVISION 1	NS - 04/11/06
REVISION 2	-
REVISION 3	-
REVISION 4	-
REVISION 5	-

EMERGENCY VEHICLES, INC.

*E.M. Holt Fire Department
Burlington, North Carolina*

MAX. HEIGHT
114"

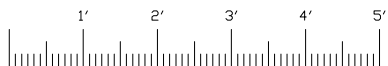
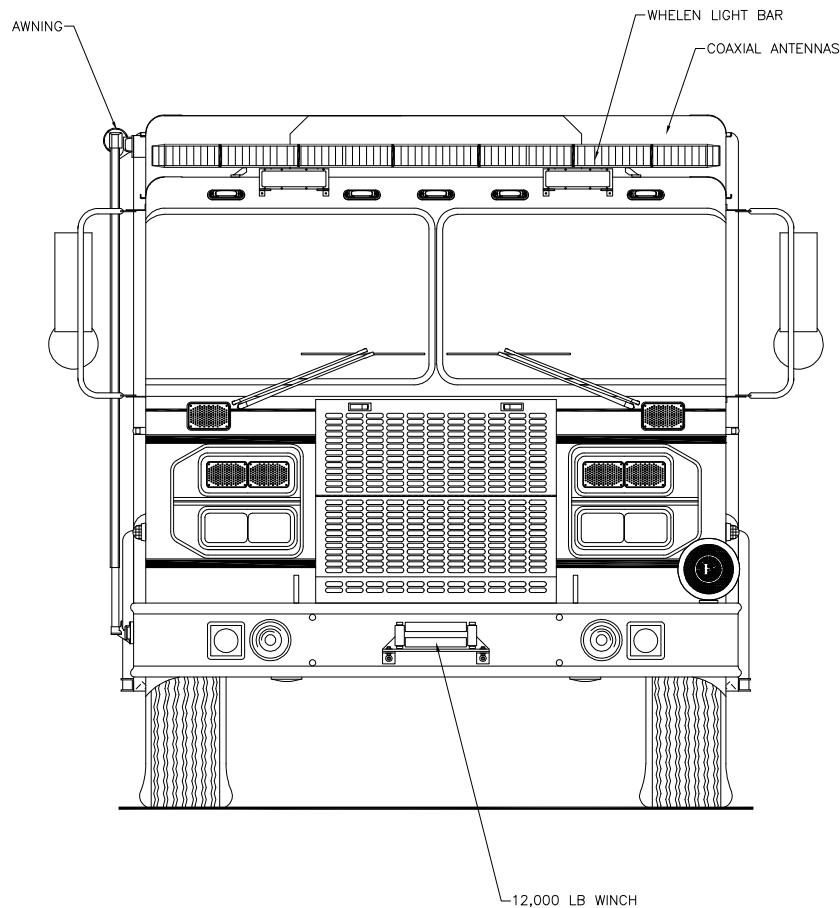

Front View

THESE DESIGN/ENGINEERING DRAWING(S) ARE THE PROPERTY OF EMERGENCY VEHICLES, INC. THEY ARE PROPRIETARY, AND ARE FOR THE EXCLUSIVE USE OF YOUR ENTITY. ANY DIVULGING OF THIS DATA TO A THIRD PARTY IS PROHIBITED.

[Signature] DATE: 08/30/05

REVISION 1	NS - 04/11/06
REVISION 2	-
REVISION 3	-
REVISION 4	-
REVISION 5	-