

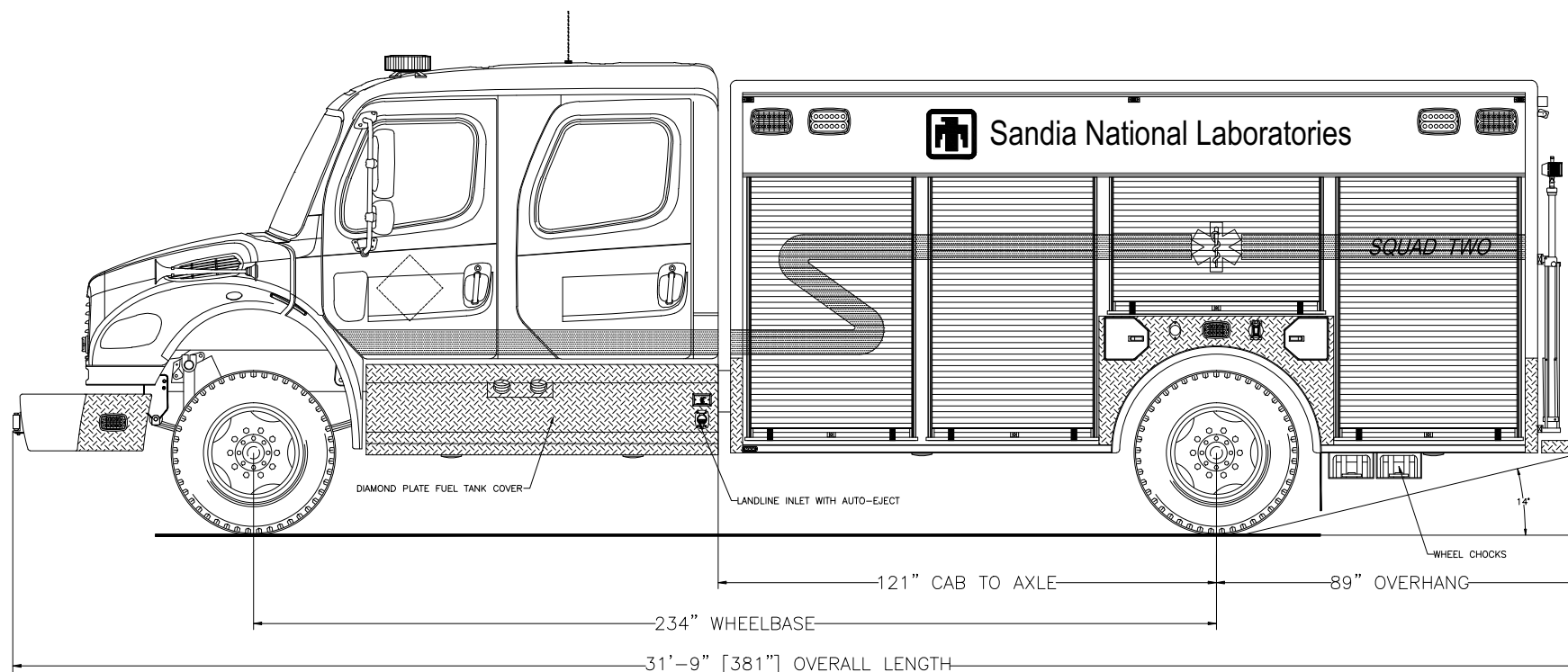

705 13TH STREET, LAKE PARK, FL
800-848-6652

*Sandia National Labs
Albuquerque, New Mexico*



Streetside Overall

THESE DESIGN/ENGINEERING DRAWING(S) ARE THE PROPERTY OF EMERGENCY VEHICLES, INC. THEY ARE PROPRIETARY, AND ARE FOR THE EXCLUSIVE USE OF YOUR ENTITY. ANY DIVULGING OF THIS DATA TO A THIRD PARTY IS PROHIBITED.

E. J. ... DATE: 04/05/13

REVISION 1	ACS - 06/05/13
REVISION 2	NS - 09/16/13
REVISION 3	-
REVISION 4	-
REVISION 5	-



705 13TH STREET, LAKE PARK, FL
800-848-6652

*Sandia National Labs
Albuquerque, New Mexico*

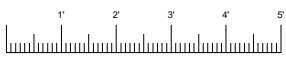
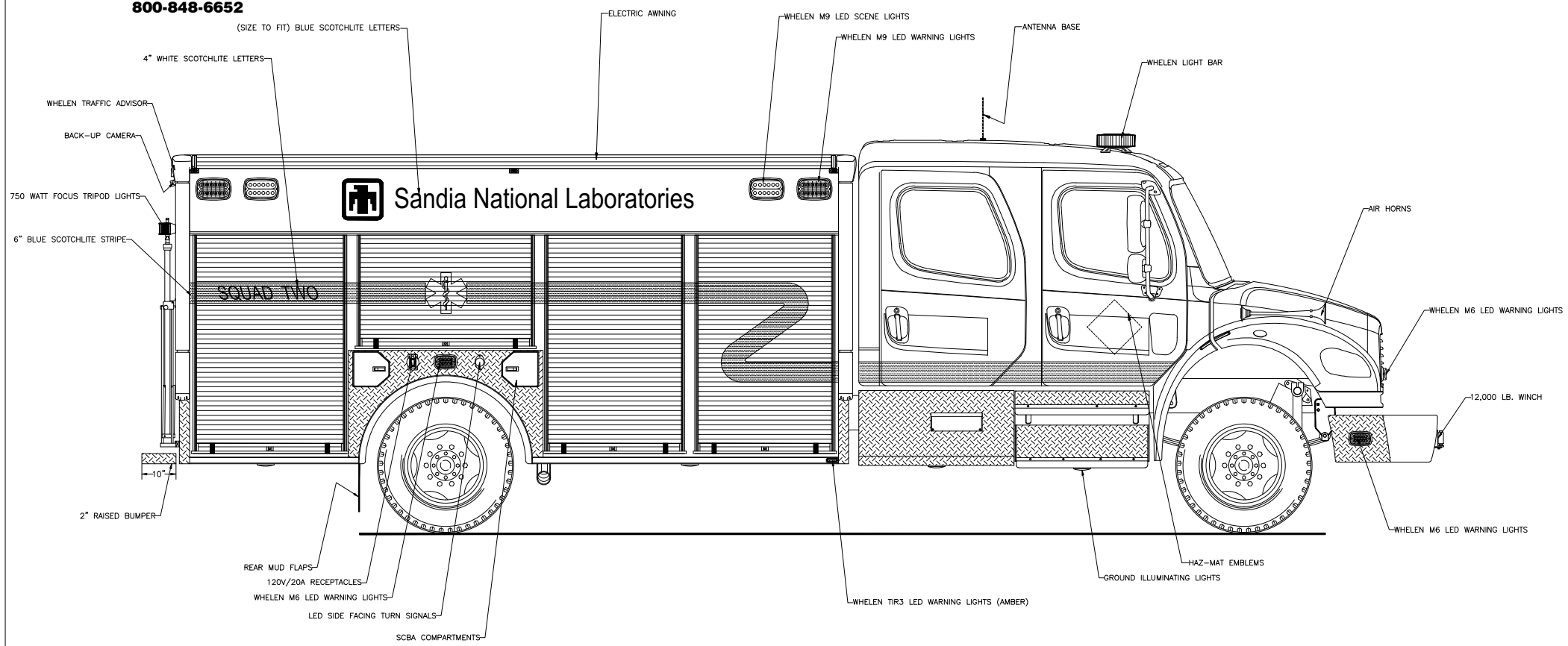

Curbside Overall

THESE DESIGN/ENGINEERING DRAWING(S) ARE THE PROPERTY OF EMERGENCY VEHICLES, INC. THEY ARE PROPRIETARY, AND ARE FOR THE EXCLUSIVE USE OF YOUR ENTITY. ANY DIVULGING OF THIS DATA TO A THIRD PARTY IS PROHIBITED.

<i>[Signature]</i>		DATE: 04/05/13
REVISION 1	ACS	06/05/13
REVISION 2	NS	09/16/13
REVISION 3	-	-
REVISION 4	-	-
REVISION 5	-	-



705 13TH STREET, LAKE PARK, FL
800-848-6652

*Sandia National Labs
Albuquerque, New Mexico*

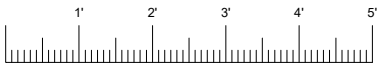
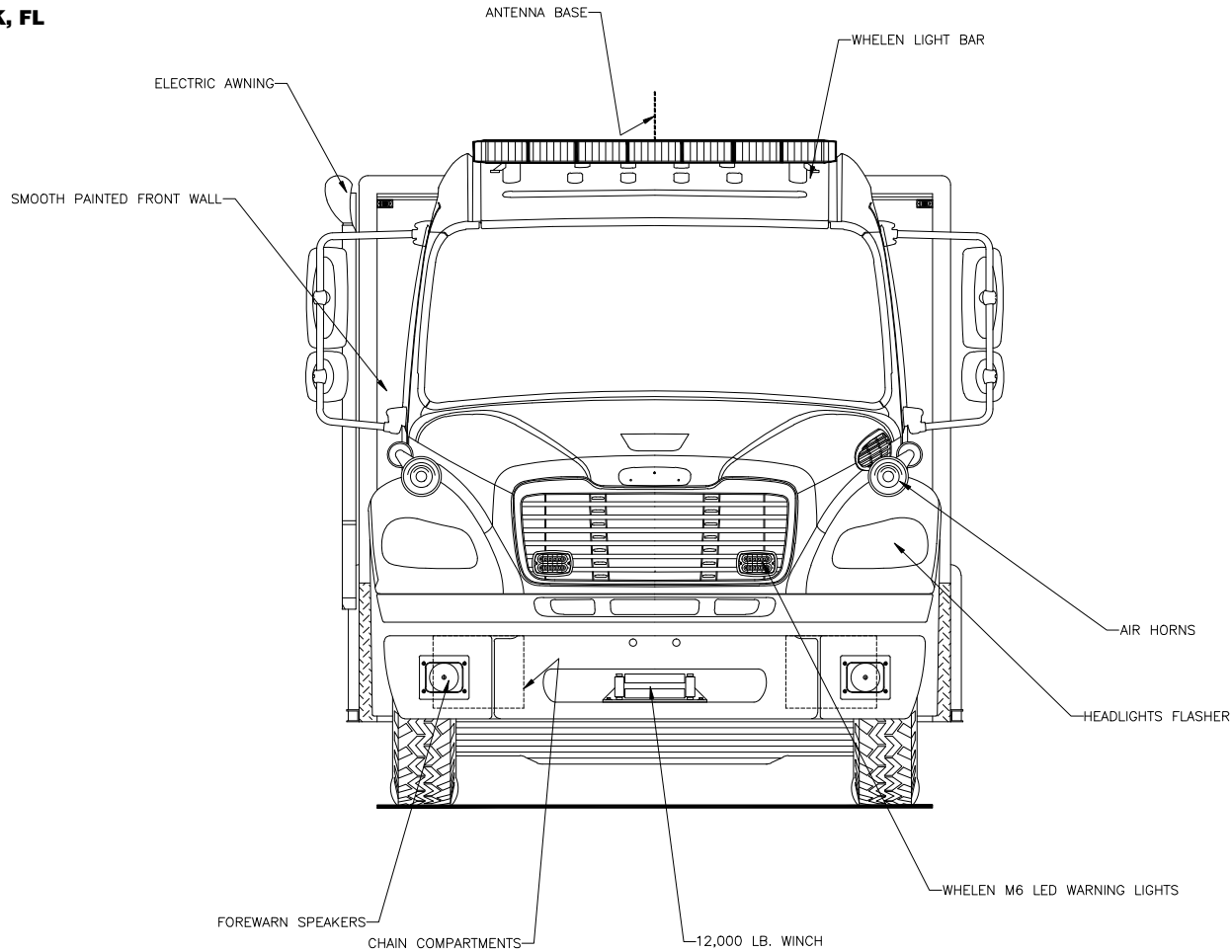

Front View

THESE DESIGN/ENGINEERING DRAWING(S) ARE THE PROPERTY OF EMERGENCY VEHICLES, INC. THEY ARE PROPRIETARY, AND ARE FOR THE EXCLUSIVE USE OF YOUR ENTITY. ANY DIVULGING OF THIS DATA TO A THIRD PARTY IS PROHIBITED.

		DATE: 04/05/13
REVISION 1	ACS	06/05/13
REVISION 2	NS	09/16/13
REVISION 3	-	-
REVISION 4	-	-
REVISION 5	-	-



705 13TH STREET, LAKE PARK, FL
800-848-6652

Sandia National Labs Albuquerque, New Mexico

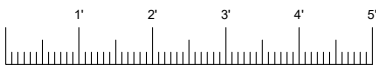
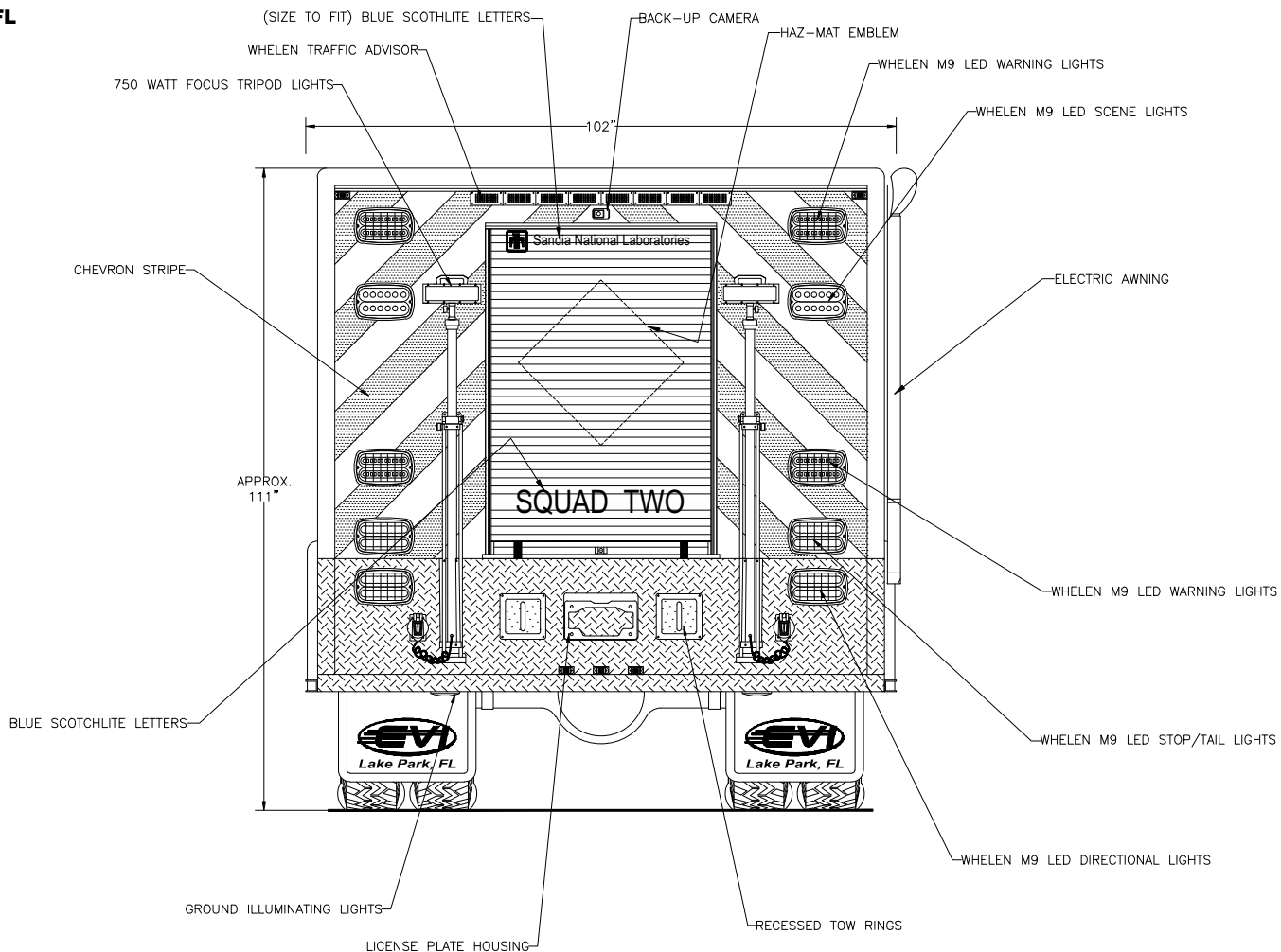

Rear View

THESE DESIGN/ENGINEERING DRAWING(S) ARE THE PROPERTY OF EMERGENCY VEHICLES, INC. THEY ARE PROPRIETARY, AND ARE FOR THE EXCLUSIVE USE OF YOUR ENTITY. ANY DIVULGING OF THIS DATA TO A THIRD PARTY IS PROHIBITED.

		DATE: 04/05/13
REVISION 1	ACS	06/05/13
REVISION 2	NS	09/16/13
REVISION 3	-	-
REVISION 4	-	-
REVISION 5	-	-