

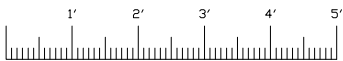

705 13TH STREET, LAKE PARK, FL
800-848-6652

Ossipee Corner Fire Department
Ossipee, New Hampshire

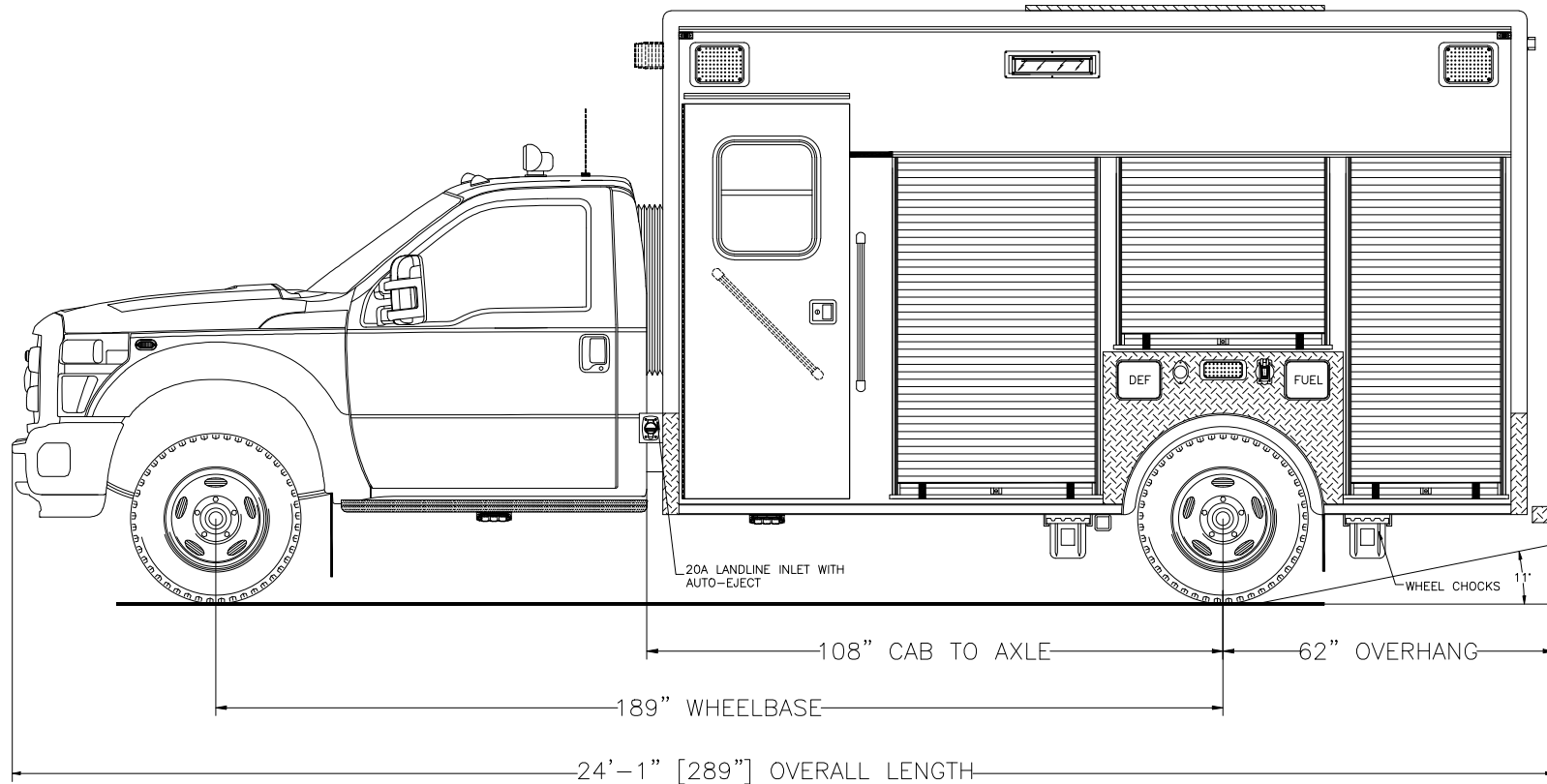

Streetside Overall

THESE DESIGN/ENGINEERING DRAWING(S) ARE THE PROPERTY OF EMERGENCY VEHICLES, INC. THEY ARE PROPRIETARY AND ARE FOR THE EXCLUSIVE USE OF YOUR ENTITY. ANY DIVULGING OF THIS DATA TO A THIRD PARTY IS PROHIBITED.

		DATE: 10/05/15
REVISION 1	ACS	02/24/16
REVISION 2	NS	03/22/16
REVISION 3	ACS	04/04/16
REVISION 4	-	-
REVISION 5	-	-



**705 13TH STREET, LAKE PARK, FL
800-848-6652**

Ossipee Corner Fire Department Ossipee, New Hampshire

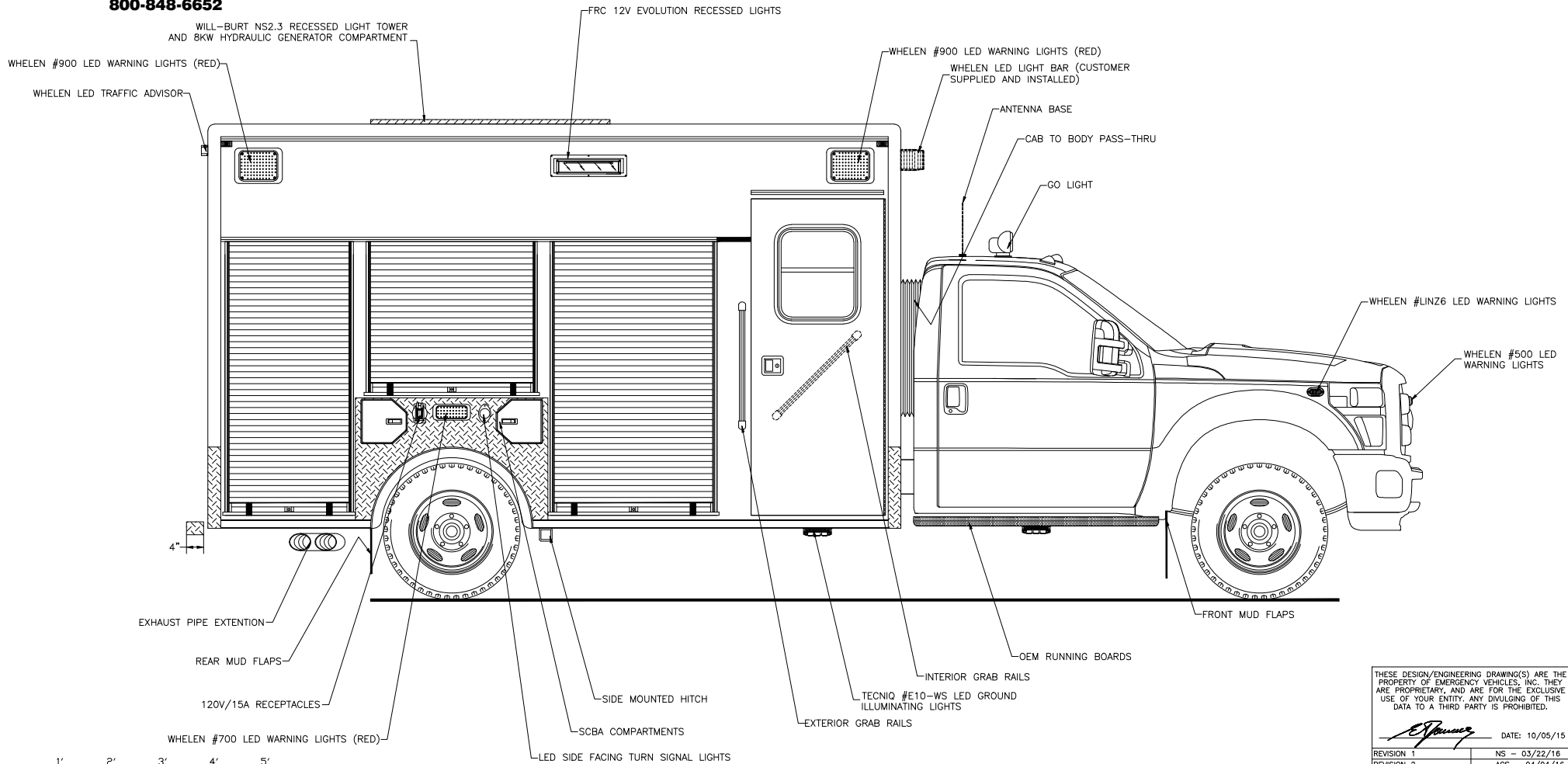

THESE DESIGN/ENGINEERING DRAWING(S) ARE THE PROPERTY OF EMERGENCY VEHICLES, INC. THEY ARE PROPRIETARY AND ARE FOR THE EXCLUSIVE USE OF YOUR ENTITY. ANY DIVULGING OF THIS DATA TO A THIRD PARTY IS PROHIBITED.

E. J. ... DATE: 10/05/15

REVISION 1	NS - 03/22/16
REVISION 2	ACS - 04/04/16
REVISION 3	-
REVISION 4	-
REVISION 5	-

Curbside Overall



**705 13TH STREET, LAKE PARK, FL
800-848-6652**

WILL-BURT NS2.3 RECESSED LIGHT TOWER
AND 8KW HYDRAULIC GENERATOR COMPARTMENT

Ossipee Corner Fire Department Ossipee, New Hampshire

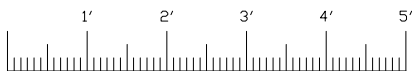
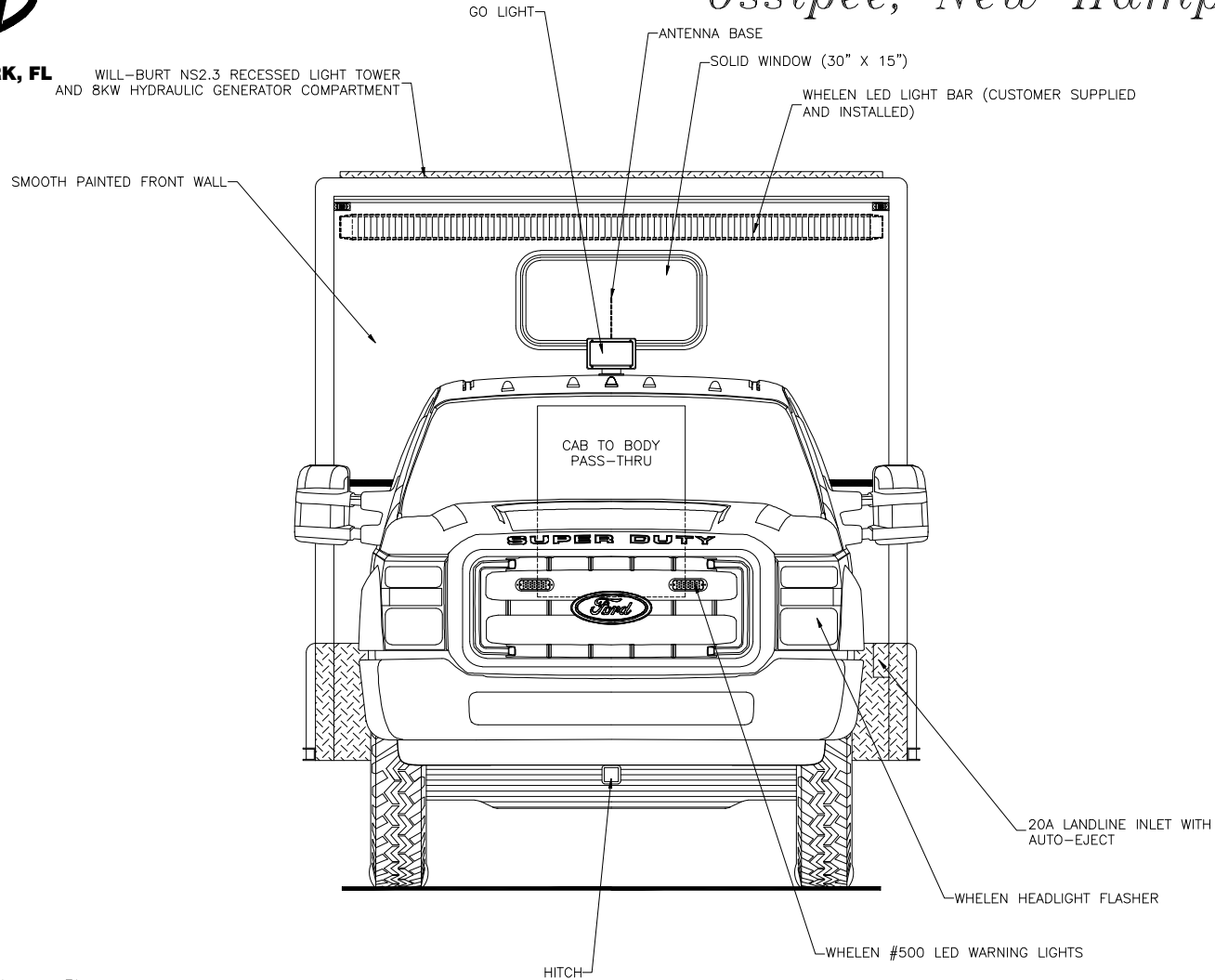

Front View

THESE DESIGN/ENGINEERING DRAWING(S) ARE THE PROPERTY OF EMERGENCY VEHICLES, INC. THEY ARE PROPRIETARY AND ARE FOR THE EXCLUSIVE USE OF YOUR ENTITY. ANY DIVULGING OF THIS DATA TO A THIRD PARTY IS PROHIBITED.

		DATE: 10/05/15
REVISION 1	NS	- 03/22/16
REVISION 2	ACS	- 04/04/16
REVISION 3	-	-
REVISION 4	-	-
REVISION 5	-	-



705 13TH STREET, LAKE PARK, FL
800-848-6652

Ossipee Corner Fire Department Ossipee, New Hampshire

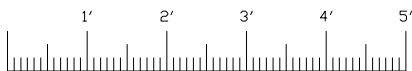
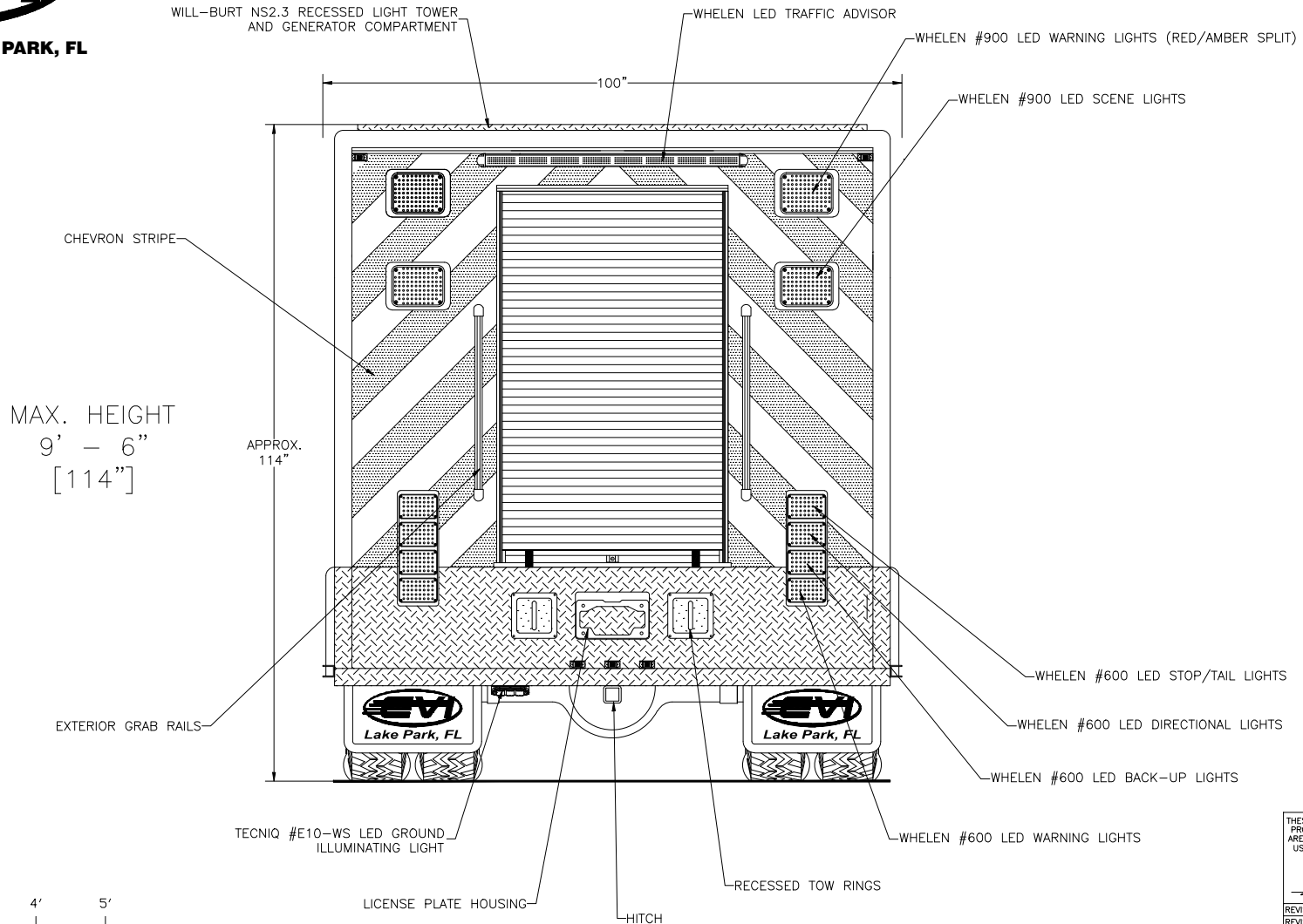

Rear View

THESE DESIGN/ENGINEERING DRAWING(S) ARE THE PROPERTY OF EMERGENCY VEHICLES, INC. THEY ARE PROPRIETARY AND ARE FOR THE EXCLUSIVE USE OF YOUR ENTITY. ANY DIVULGING OF THIS DATA TO A THIRD PARTY IS PROHIBITED.

REVISION 1	NS - 03/22/16	DATE: 10/05/15
REVISION 2	ACS - 04/04/16	
REVISION 3	-	
REVISION 4	-	
REVISION 5	-	