

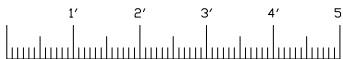

705 13TH STREET, LAKE PARK, FL
800-848-6652

Waukomis Fire Department
Waukomis, Oklahoma

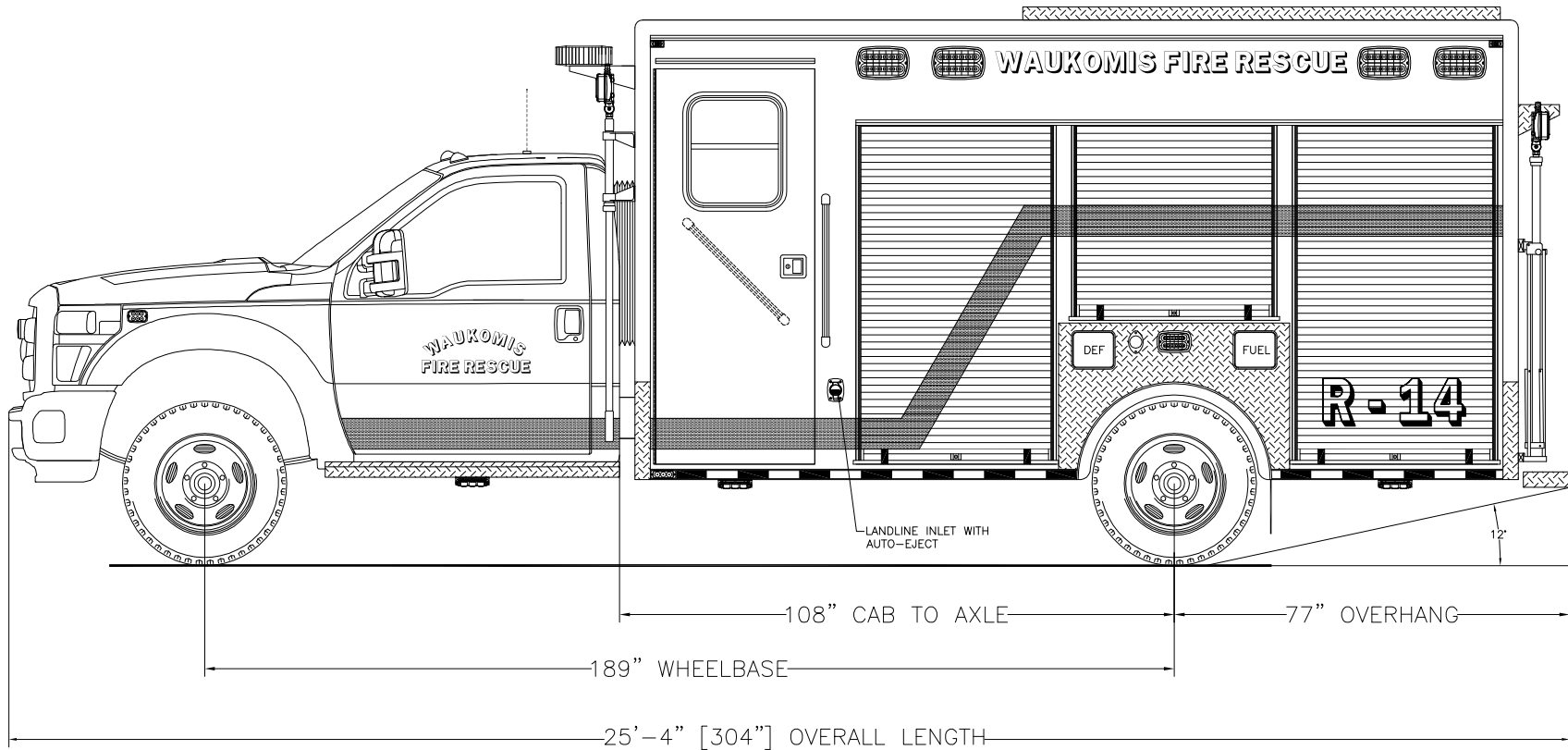

Streetside Overall

THESE DESIGN/ENGINEERING DRAWING(S) ARE THE PROPERTY OF EMERGENCY VEHICLES, INC. THEY ARE PROPRIETARY, AND ARE FOR THE EXCLUSIVE USE OF YOUR ENTITY. ANY DIVULGING OF THIS DATA TO A THIRD PARTY IS PROHIBITED.

		DATE: 08/07/14
REVISION 1	ACS - 08/14/14	
REVISION 2	ACS - 12/11/14	
REVISION 3	ACS - 03/04/15	
REVISION 4	ACS - 05/18/15	
REVISION 5	-	



705 13TH STREET, LAKE PARK, FL
800-848-6652

Waukomis Fire Department Waukomis, Oklahoma

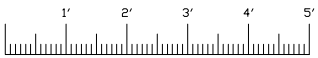
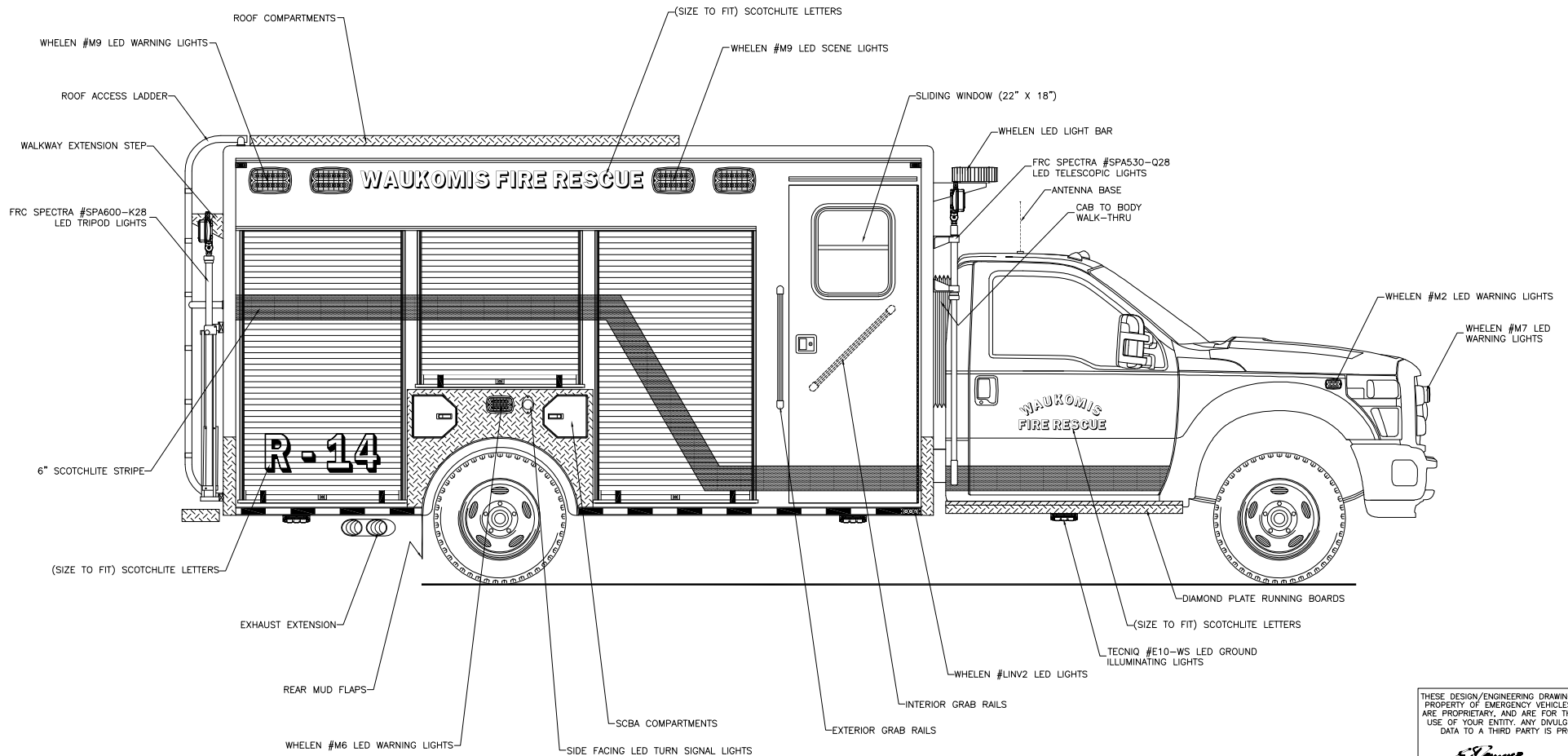

Curbside Overall

THESE DESIGN/ENGINEERING DRAWING(S) ARE THE PROPERTY OF EMERGENCY VEHICLES, INC. THEY ARE PROPRIETARY, AND ARE FOR THE EXCLUSIVE USE OF YOUR ENTITY. ANY DIVULGING OF THIS DATA TO A THIRD PARTY IS PROHIBITED.

<i>EVI</i> DATE: 08/07/14	
REVISION 1	ACS - 08/14/14
REVISION 2	ACS - 12/11/14
REVISION 3	ACS - 03/04/15
REVISION 4	ACS - 05/18/15
REVISION 5	-



705 13TH STREET, LAKE PARK, FL
800-848-6652

Waukomis Fire Department Waukomis, Oklahoma

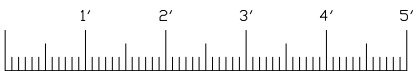
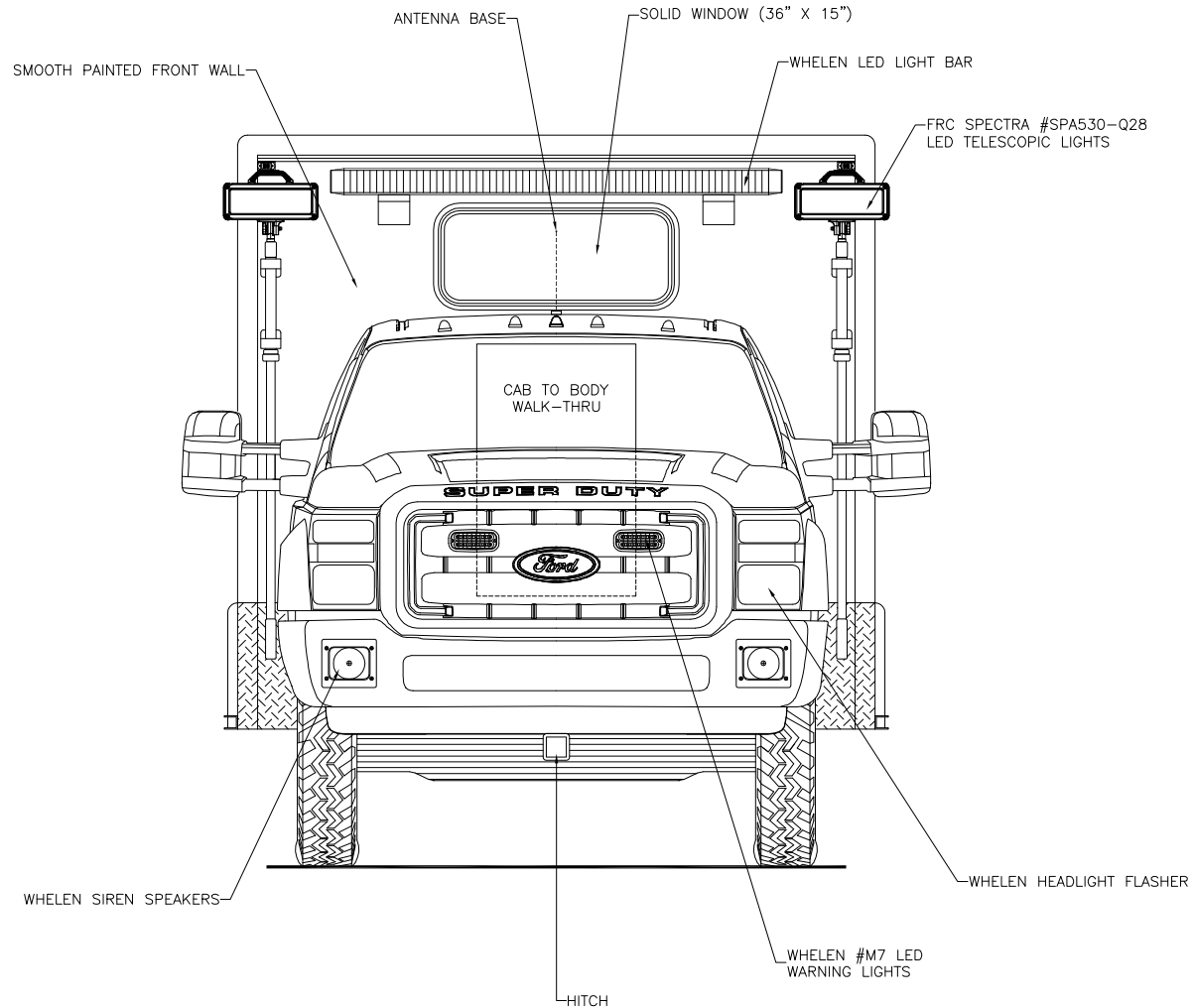

Front View

THESE DESIGN/ENGINEERING DRAWING(S) ARE THE PROPERTY OF EMERGENCY VEHICLES, INC. THEY ARE PROPRIETARY, AND ARE FOR THE EXCLUSIVE USE OF YOUR ENTITY. ANY DIVULGING OF THIS DATA TO A THIRD PARTY IS PROHIBITED.

		DATE: 08/07/14
REVISION 1	ACS	08/14/14
REVISION 2	ACS	12/11/14
REVISION 3	ACS	03/04/15
REVISION 4	-	-
REVISION 5	-	-



705 13TH STREET, LAKE PARK, FL
800-848-6652

Waukomis Fire Department Waukomis, Oklahoma

MAX. HEIGHT
110"

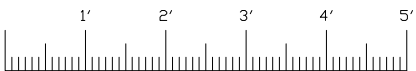
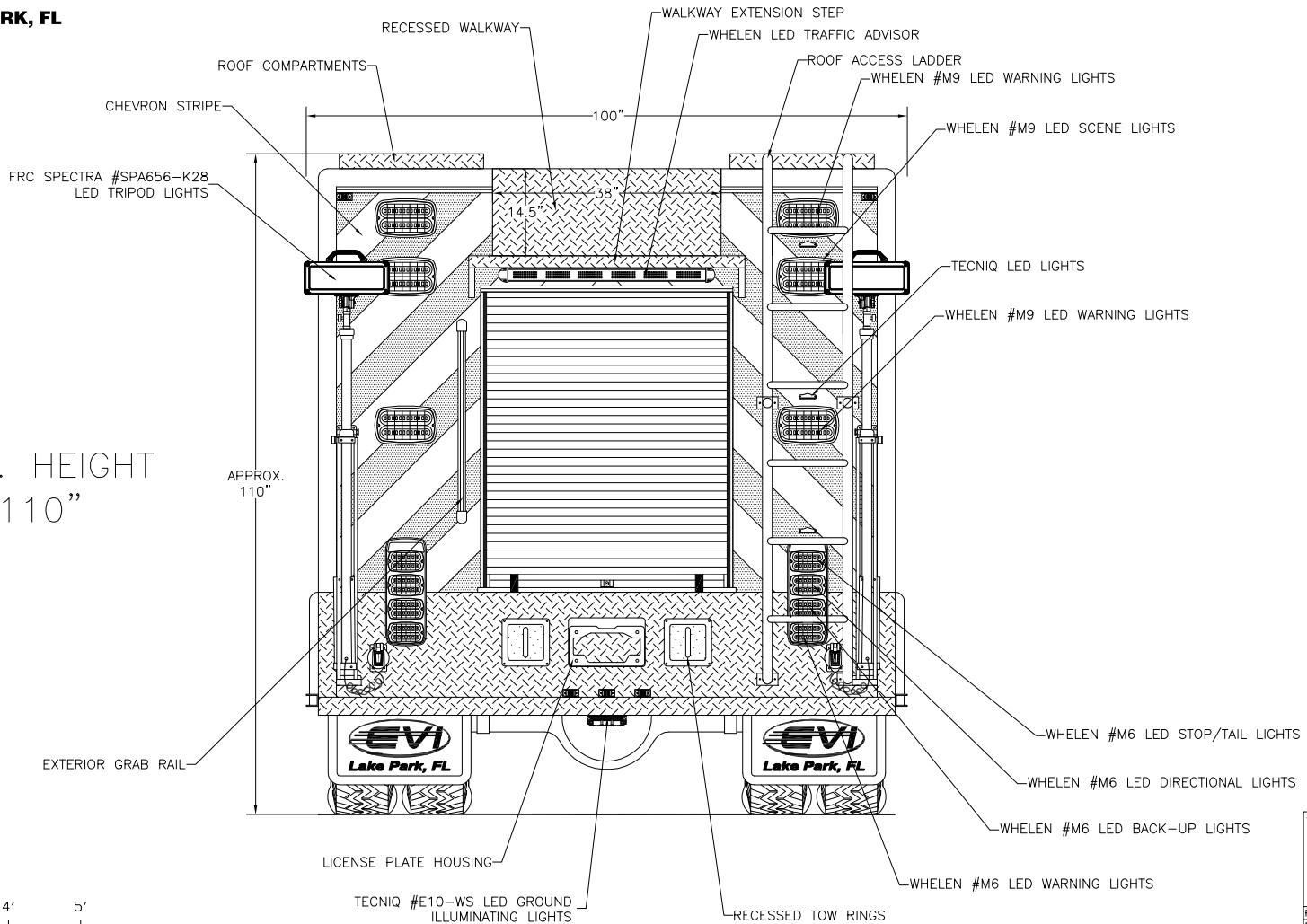

Rear View

THESE DESIGN/ENGINEERING DRAWING(S) ARE THE PROPERTY OF EMERGENCY VEHICLES, INC. THEY ARE PROPRIETARY, AND ARE FOR THE EXCLUSIVE USE OF YOUR ENTITY. ANY DIVULGING OF THIS DATA TO A THIRD PARTY IS PROHIBITED.

EVI DATE: 08/07/14

REVISION 1	ACS - 08/14/14
REVISION 2	ACS - 12/11/14
REVISION 3	ACS - 03/04/15
REVISION 4	ACS - 05/07/15
REVISION 5	-