

EMERGENCY VEHICLES, INC.

*Drug Enforcement Administration
Washington D.C.*

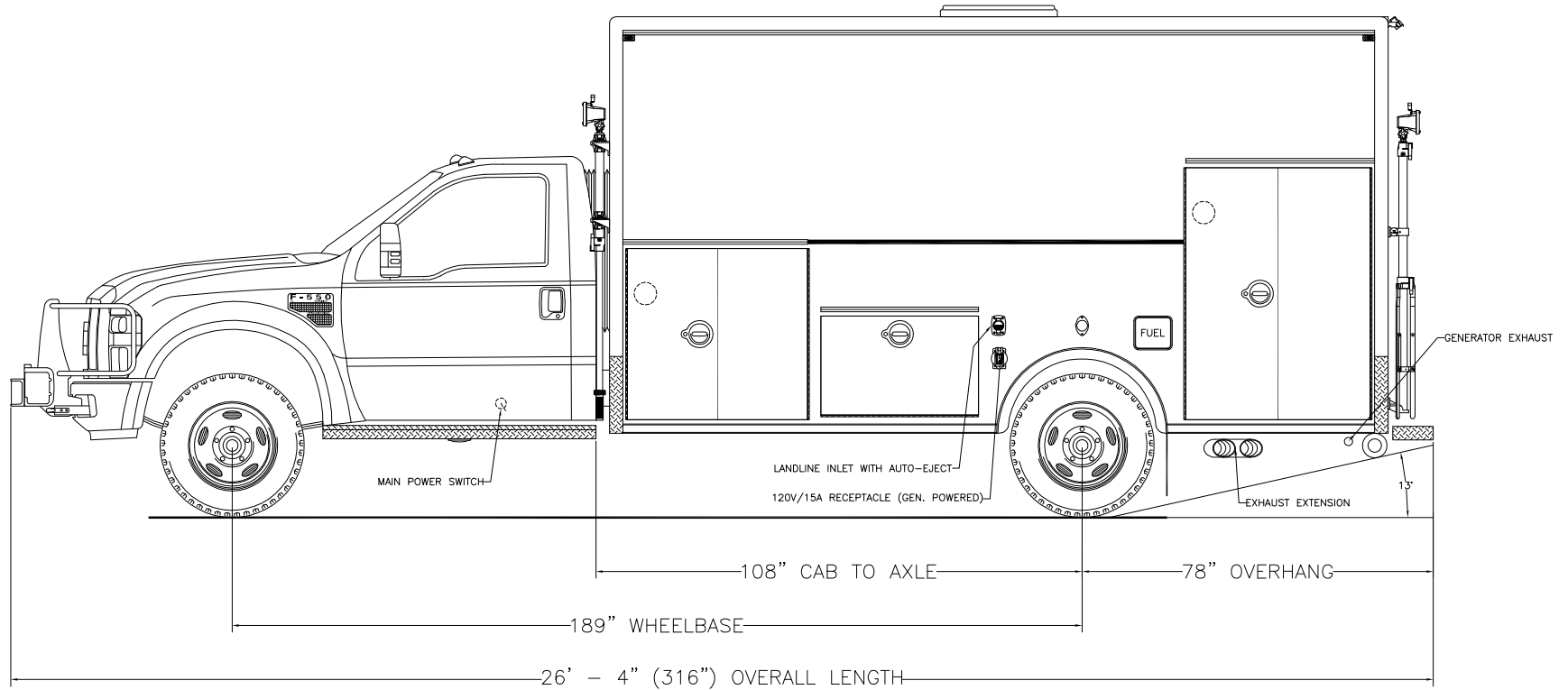

THESE DESIGN/ENGINEERING DRAWING(S) ARE THE PROPERTY OF EMERGENCY VEHICLES, INC. THEY ARE PROPRIETARY, AND ARE FOR THE EXCLUSIVE USE OF YOUR ENTITY. ANY DIVULGING OF THIS DATA TO A THIRD PARTY IS PROHIBITED.

<i>EJ Pinner</i>		DATE: 05/11/09
REVISION 1	NS	05/28/09
REVISION 2	NS	07/13/09
REVISION 3	NS	08/06/09
REVISION 4	GR	01/06/10
REVISION 5	-	-

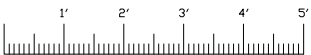

Streetside Overall

EMERGENCY VEHICLES, INC.

*Drug Enforcement Administration
Washington D.C.*

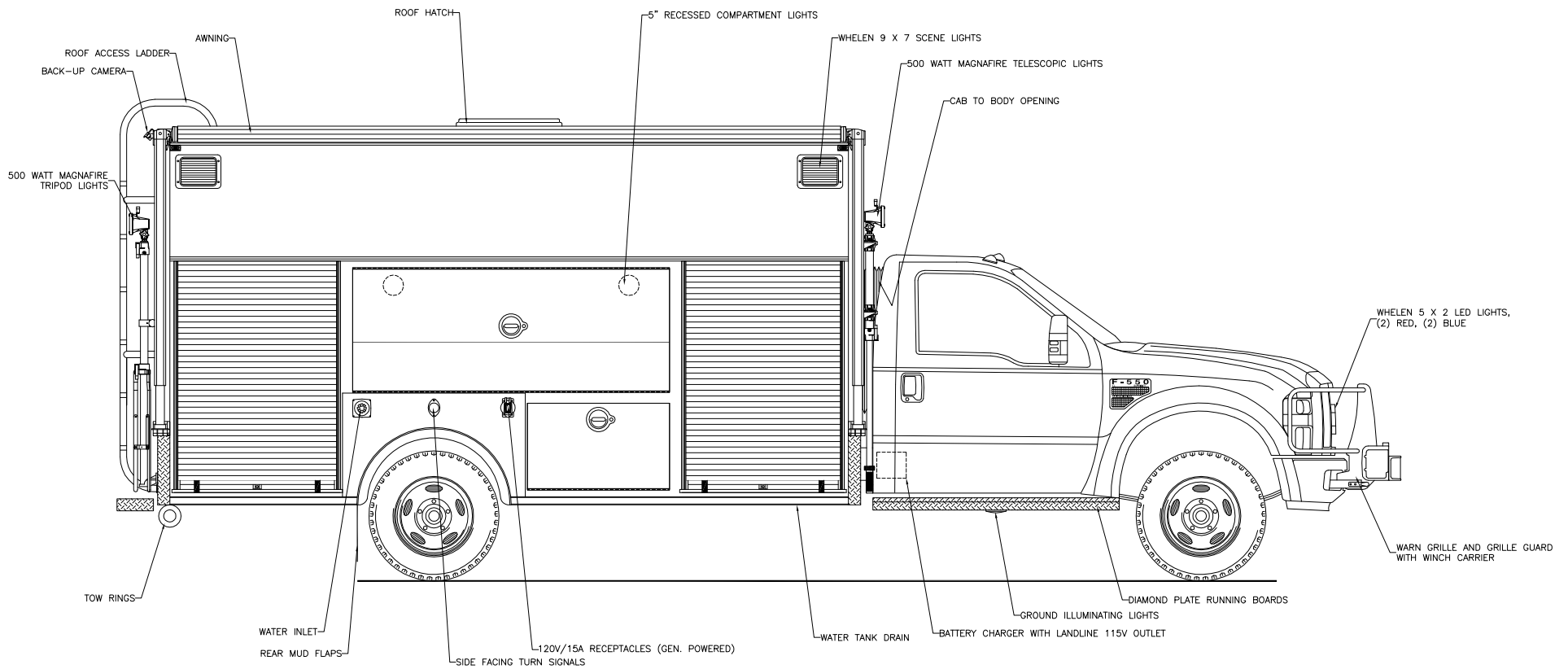

THESE DESIGN/ENGINEERING DRAWING(S) ARE THE PROPERTY OF EMERGENCY VEHICLES, INC. THEY ARE PROPRIETARY, AND ARE FOR THE EXCLUSIVE USE OF YOUR ENTITY. ANY DIVULGING OF THIS DATA TO A THIRD PARTY IS PROHIBITED.

E.V. Inc. DATE: 05/11/09

REVISION 1	NS - 05/28/09
REVISION 2	NS - 07/13/09
REVISION 3	NS - 08/06/09
REVISION 4	GR - 01/06/10
REVISION 5	-

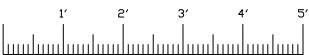

Curbside Overall

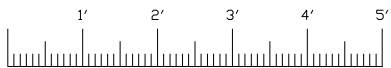
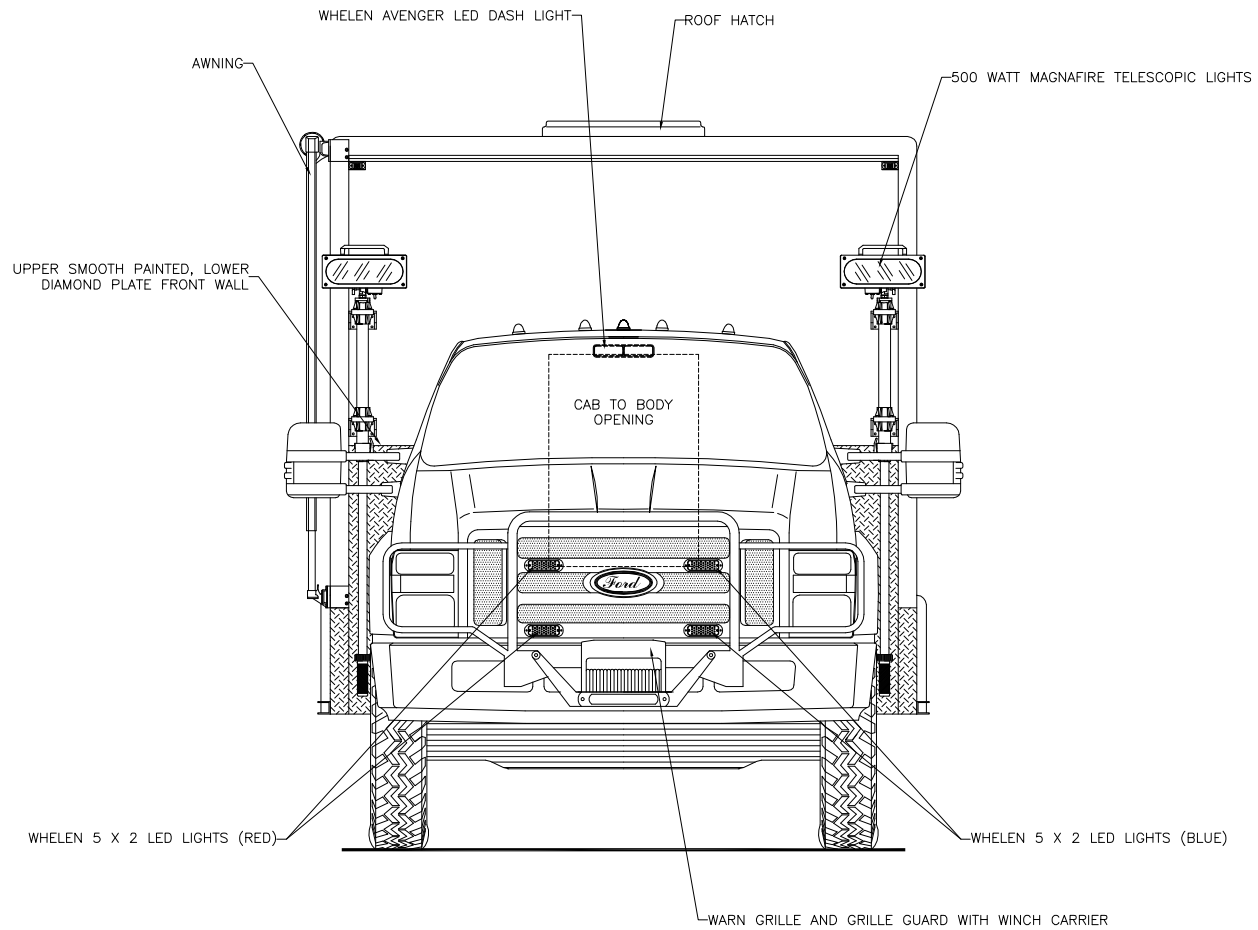

Front View

THESE DESIGN/ENGINEERING DRAWING(S) ARE THE PROPERTY OF EMERGENCY VEHICLES, INC. THEY ARE PROPRIETARY, AND ARE FOR THE EXCLUSIVE USE OF YOUR ENTITY. ANY DULGING OF THIS DATA TO A THIRD PARTY IS PROHIBITED.

<i>E.V. Inc.</i>		DATE: 05/11/09
REVISION 1	NS	05/28/09
REVISION 2	NS	07/13/09
REVISION 3	NS	08/06/09
REVISION 4	GR	01/06/10
REVISION 5	-	-

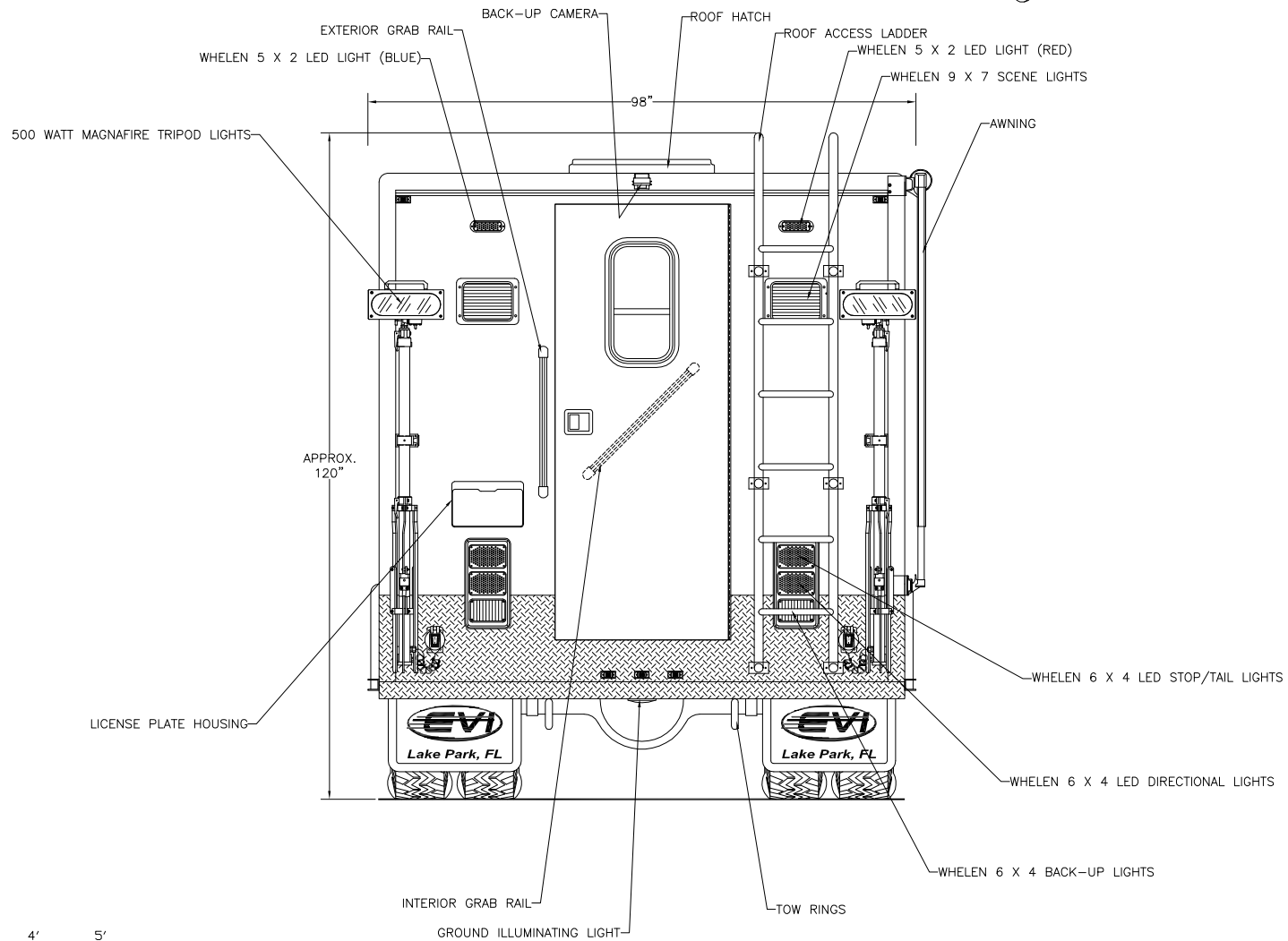

Rear View

THESE DESIGN/ENGINEERING DRAWING(S) ARE THE PROPERTY OF EMERGENCY VEHICLES, INC. THEY ARE PROPRIETARY, AND ARE FOR THE EXCLUSIVE USE OF YOUR ENTITY. ANY DIVULGING OF THIS DATA TO A THIRD PARTY IS PROHIBITED.

<i>EVI</i>		DATE: 05/11/09
REVISION 1	NS	05/28/09
REVISION 2	NS	07/13/09
REVISION 3	NS	08/06/09
REVISION 4	-	-
REVISION 5	-	-