

*EMERGENCY VEHICLES, INC.*

*Chenango Fire Company  
Binghamton, New York*

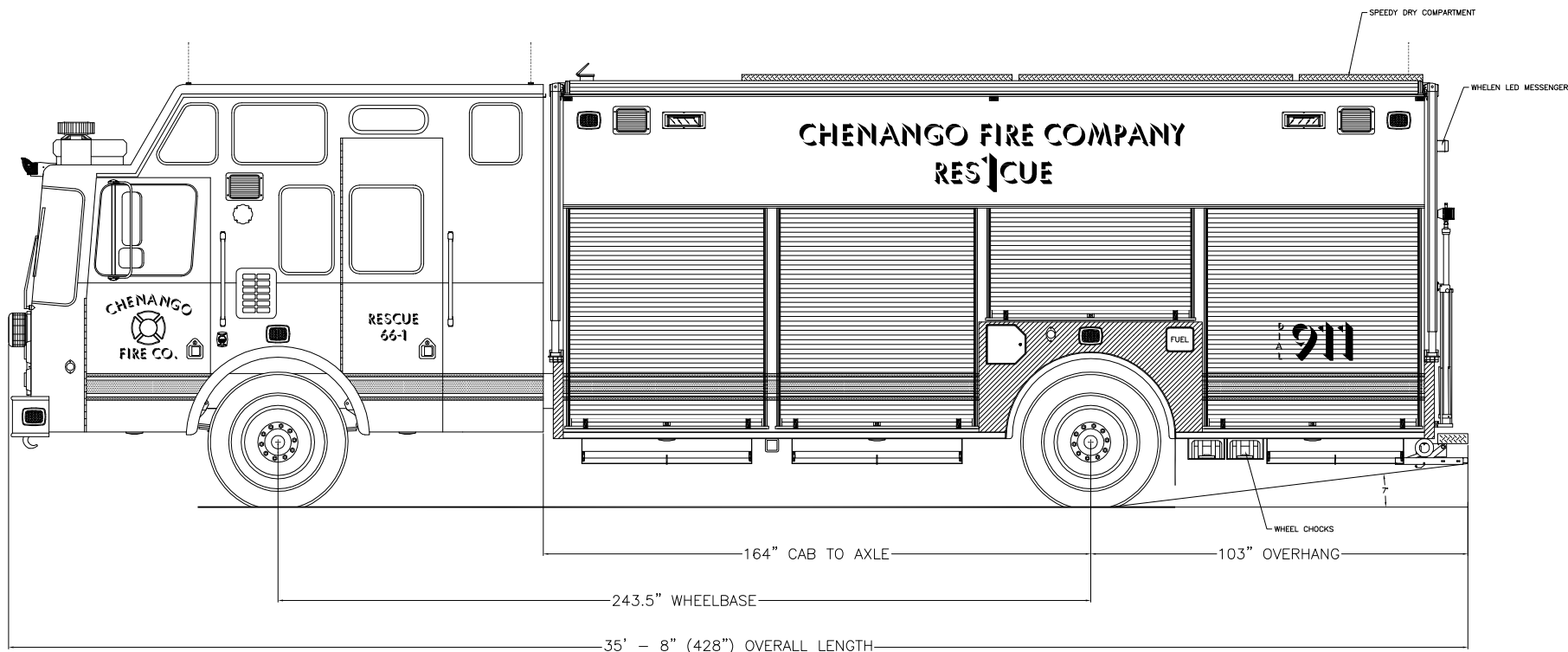

THESE DESIGN/ENGINEERING DRAWING(S) ARE THE PROPERTY OF EMERGENCY VEHICLES, INC. THEY ARE PROPRIETARY, AND ARE FOR THE EXCLUSIVE USE OF YOUR ENTITY. ANY DIVULGING OF THIS DATA TO A THIRD PARTY IS PROHIBITED.

*[Signature]* DATE: 12/06/05

REVISION 1	NS - 04/24/06
REVISION 2	NS - 06/29/06
REVISION 3	-
REVISION 4	-
REVISION 5	-

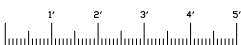

*Streetside Overall*

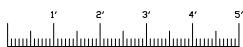
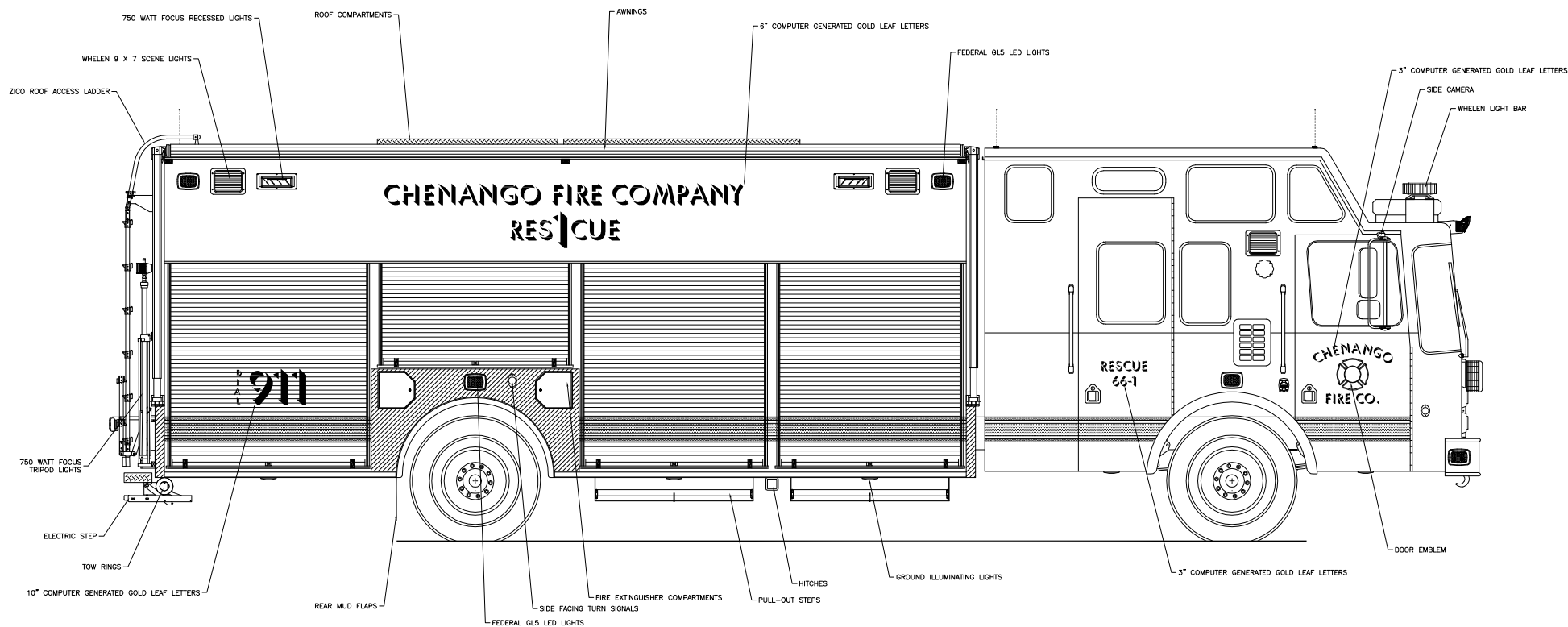

*Curbside Overall*

THESE DESIGN/ENGINEERING DRAWING(S) ARE THE PROPERTY OF EMERGENCY VEHICLES, INC. THEY ARE PROPRIETARY, AND ARE FOR THE EXCLUSIVE USE OF YOUR ENTITY. ANY DIVULGING OF THIS DATA TO A THIRD PARTY IS PROHIBITED.

		DATE: 12/06/05
REVISION 1	NS - 04/24/06	
REVISION 2	NS - 06/29/06	
REVISION 3	-	
REVISION 4	-	
REVISION 5	-	

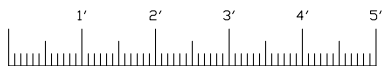
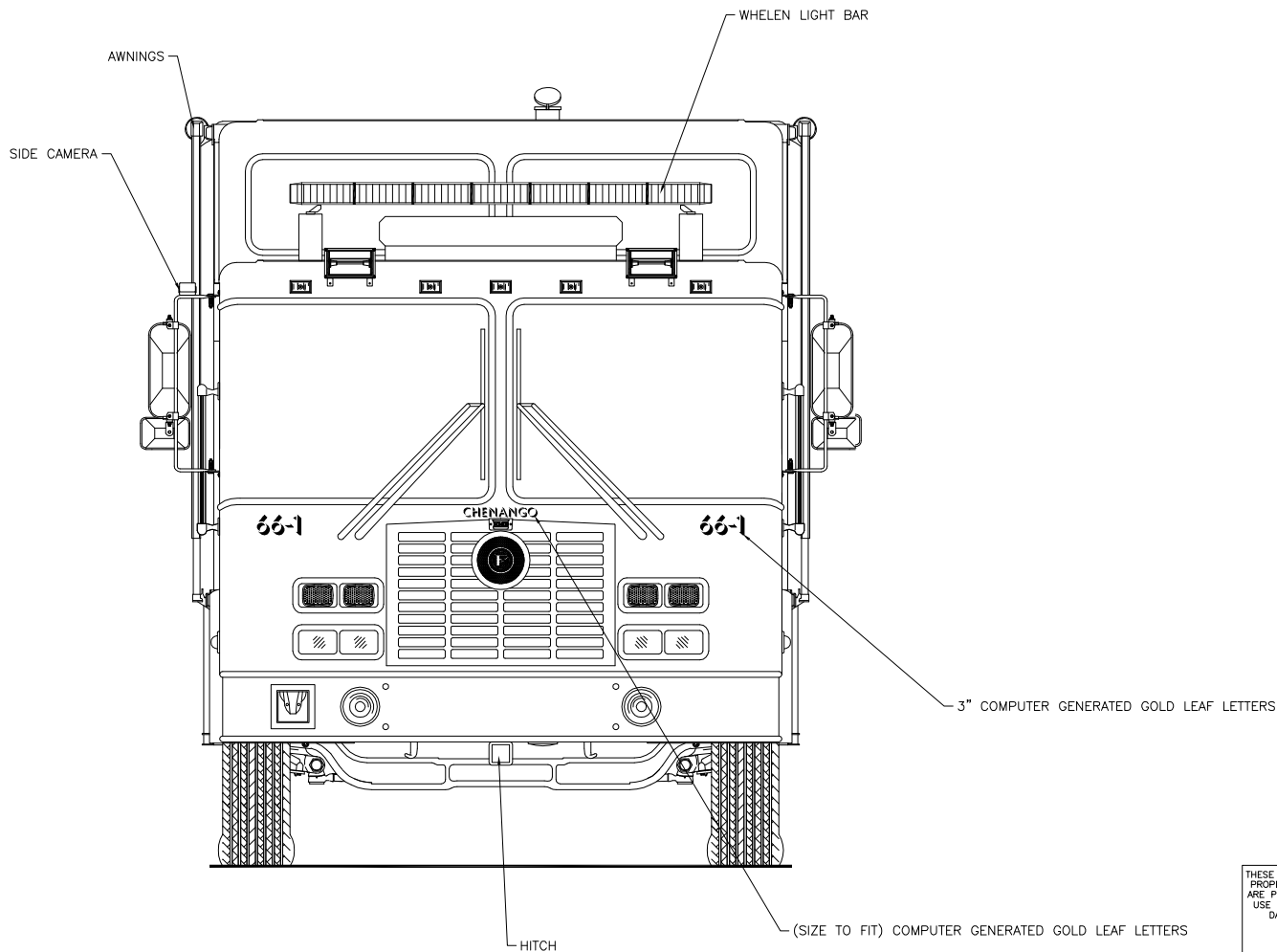

*Front View*

THESE DESIGN/ENGINEERING DRAWING(S) ARE THE PROPERTY OF EMERGENCY VEHICLES, INC. THEY ARE PROPRIETARY, AND ARE FOR THE EXCLUSIVE USE OF YOUR ENTITY. ANY DIVULGING OF THIS DATA TO A THIRD PARTY IS PROHIBITED.

		DATE: 12/06/05
REVISION 1	NS - 04/24/06	
REVISION 2	NS - 06/29/06	
REVISION 3	-	
REVISION 4	-	
REVISION 5	-	

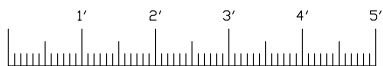
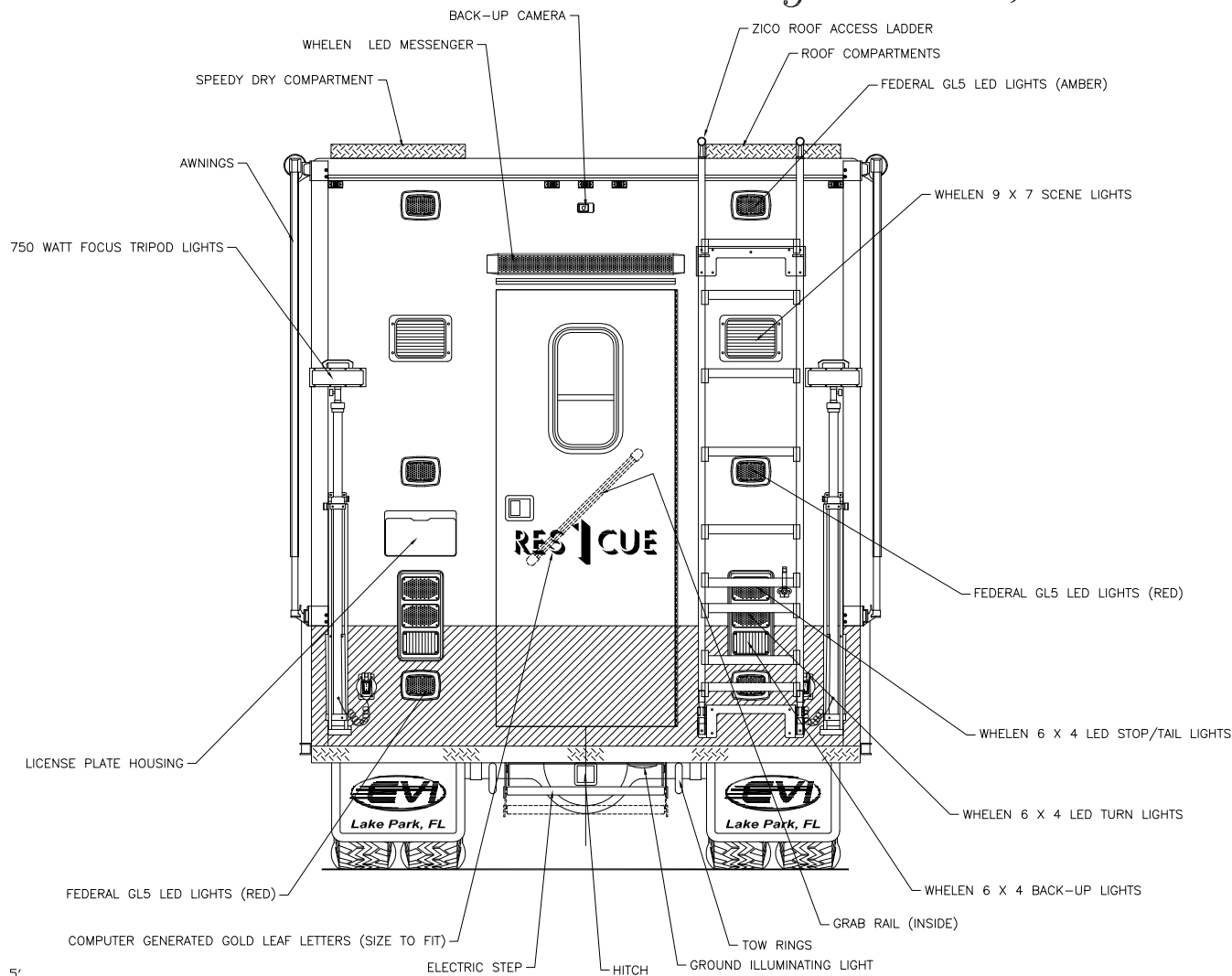

*Rear View*

THESE DESIGN/ENGINEERING DRAWING(S) ARE THE PROPERTY OF EMERGENCY VEHICLES, INC. THEY ARE PROPRIETARY, AND ARE FOR THE EXCLUSIVE USE OF YOUR ENTITY. ANY DIVULGING OF THIS DATA TO A THIRD PARTY IS PROHIBITED.

		DATE: 12/06/05
REVISION 1	NS - 04/24/06	
REVISION 2	NS - 06/29/06	
REVISION 3	-	
REVISION 4	-	
REVISION 5	-	