

EMERGENCY VEHICLES, INC.

*City of Tampa
Tampa, Florida*

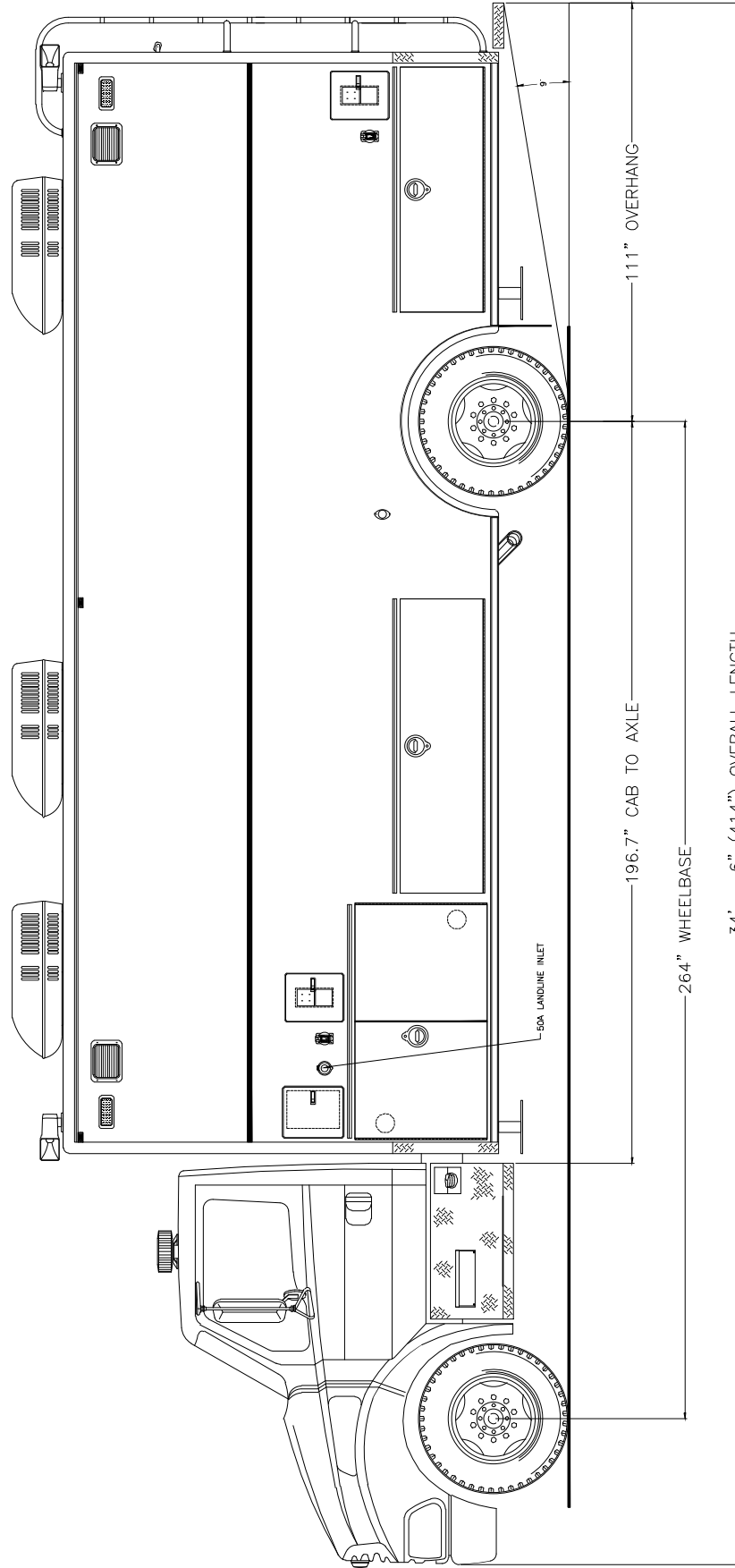

THESE DESIGN/ENGINEERING DRAWINGS ARE THE PROPERTY OF EMERGENCY VEHICLES, INC. THEIR USE FOR ANY OTHER PROJECT WITHOUT THE WRITTEN CONSENT OF EMERGENCY VEHICLES, INC. IS PROHIBITED. ANY DUPLICATION OF THIS DATA TO A THIRD PARTY IS PROHIBITED.

DATE: 01/10/06

REVISION 1	NS	02/20/06
REVISION 2		
REVISION 3		
REVISION 4		
REVISION 5		

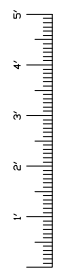

Streetside Overall

EMERGENCY VEHICLES, INC.

*City of Tampa
Tampa, Florida*

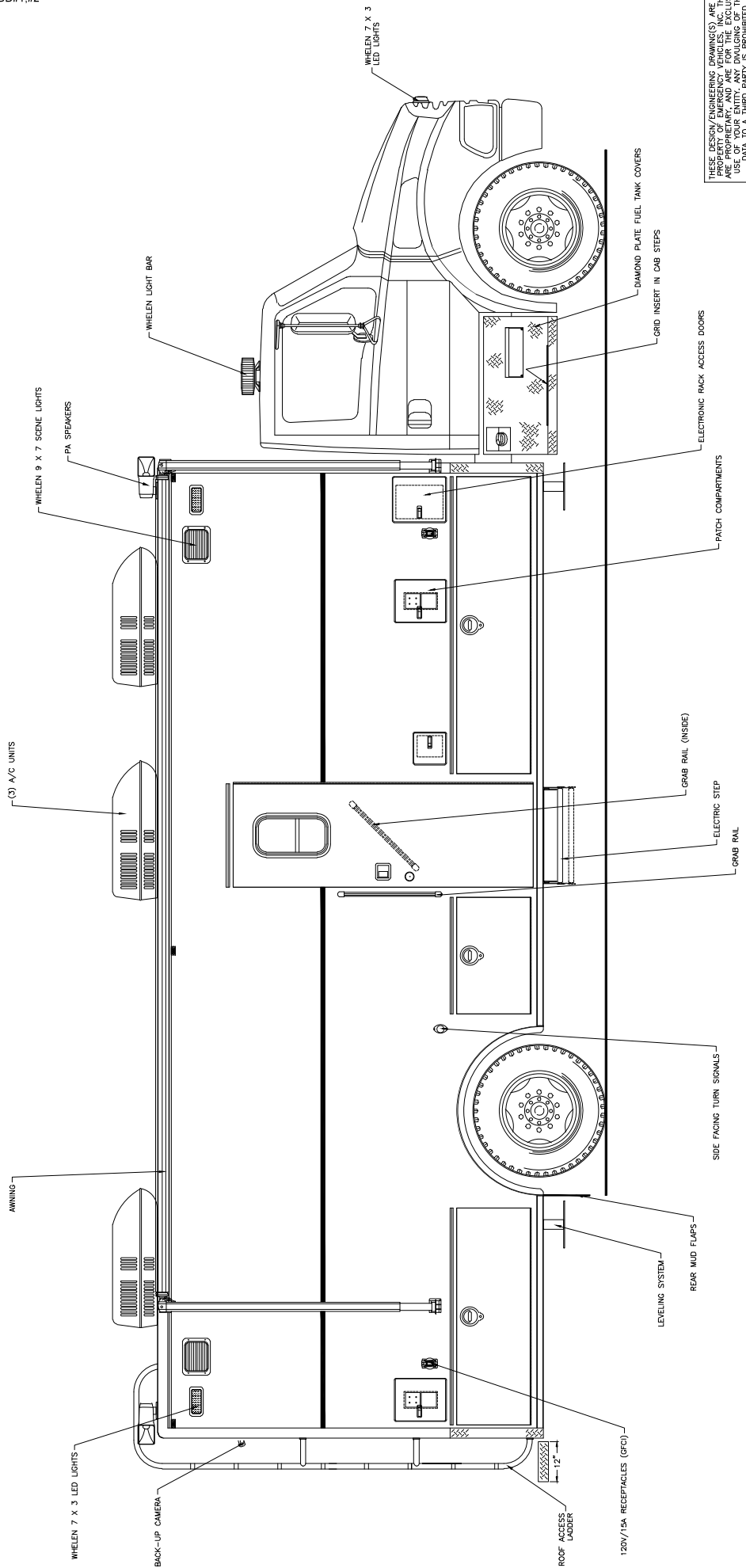

THESE DESIGN/ENGINEERING DRAWING(S) ARE THE PROPERTY OF EMERGENCY VEHICLES, INC. THESE DRAWINGS ARE TO BE USED FOR THE MANUFACTURE OF THIS DATA TO A THIRD PARTY IS PROHIBITED.

DATE: 01/10/06

REVISION 1	NS	02/20/06
REVISION 2	-	-
REVISION 3	-	-
REVISION 4	-	-
REVISION 5	-	-

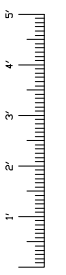

Curbside Overall

EMERGENCY VEHICLES, INC.

*City of Tampa
Tampa, Florida*

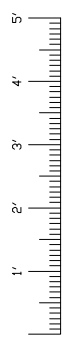
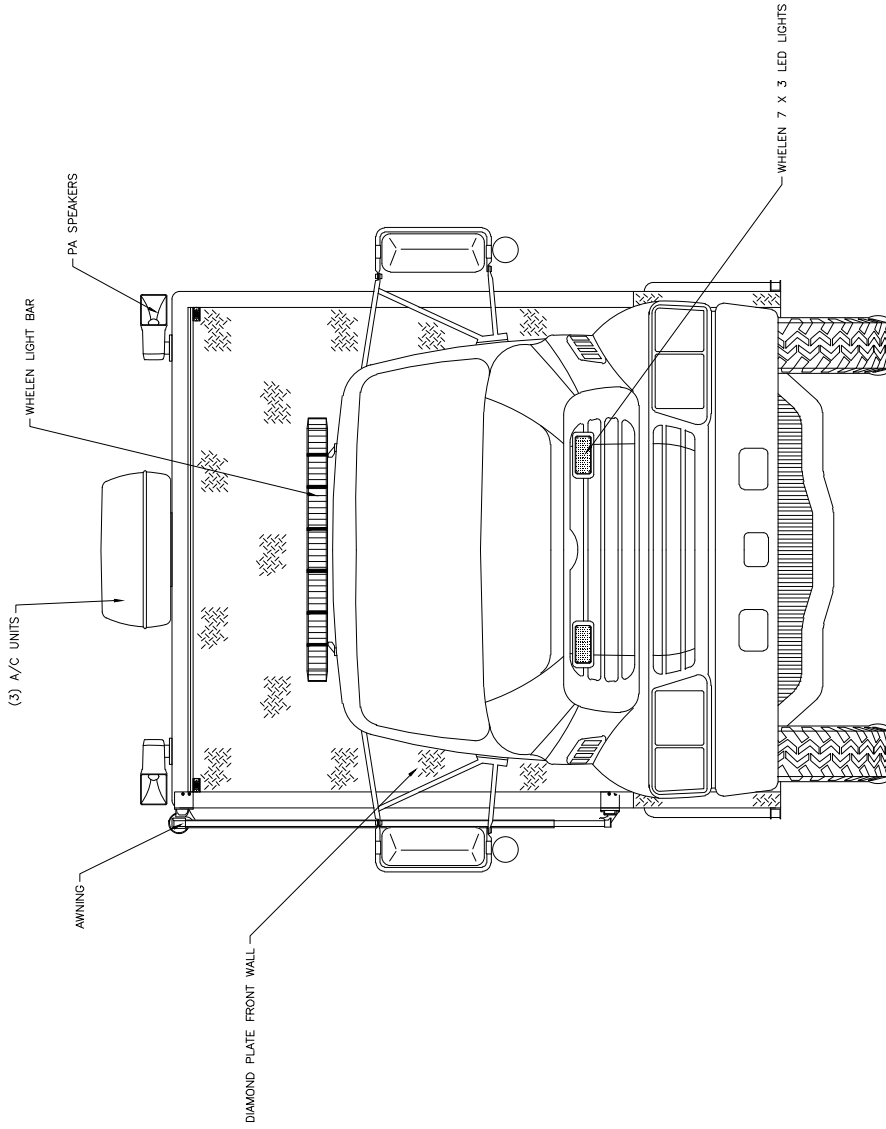

Front View

THESE DESIGN/ENGINEERING DRAWING(S) ARE THE PROPERTY OF EMERGENCY VEHICLES, INC. THIS INFORMATION IS TO BE USED ONLY FOR THE USE OF YOUR ENTITY. ANY DIVULGING OF THIS DATA TO A THIRD PARTY IS PROHIBITED.

DATE: 01/10/06

REVISION 1	NS	02/20/06
REVISION 2		
REVISION 3		
REVISION 4		
REVISION 5		

EMERGENCY VEHICLES, INC.

*City of Tampa
Tampa, Florida*

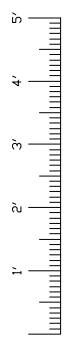
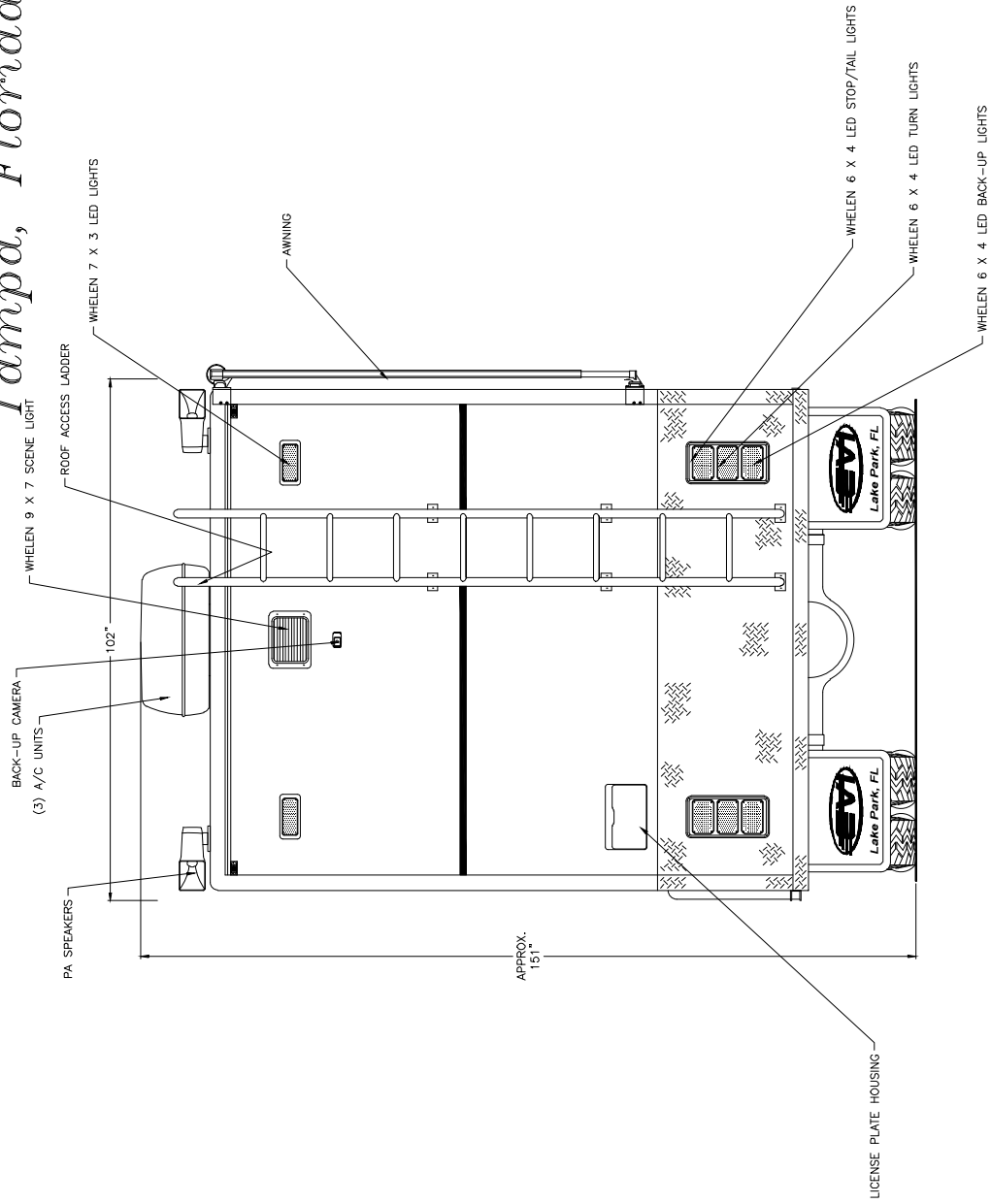

Rear View

THESE DESIGN/ENGINEERING DRAWINGS ARE THE PROPERTY OF EMERGENCY VEHICLES, INC. THIS INFORMATION IS TO BE USED FOR THE EXCLUSIVE USE OF YOUR ENTITY. ANY DIVULGING OF THIS DATA TO A THIRD PARTY IS PROHIBITED.

REVISION 1	DATE: 01/10/06
REVISION 2	NS - 02/20/06
REVISION 3	-
REVISION 4	-
REVISION 5	-