

EMERGENCY VEHICLES, INC.

Commonwealth of
Pennsylvania - PEMA

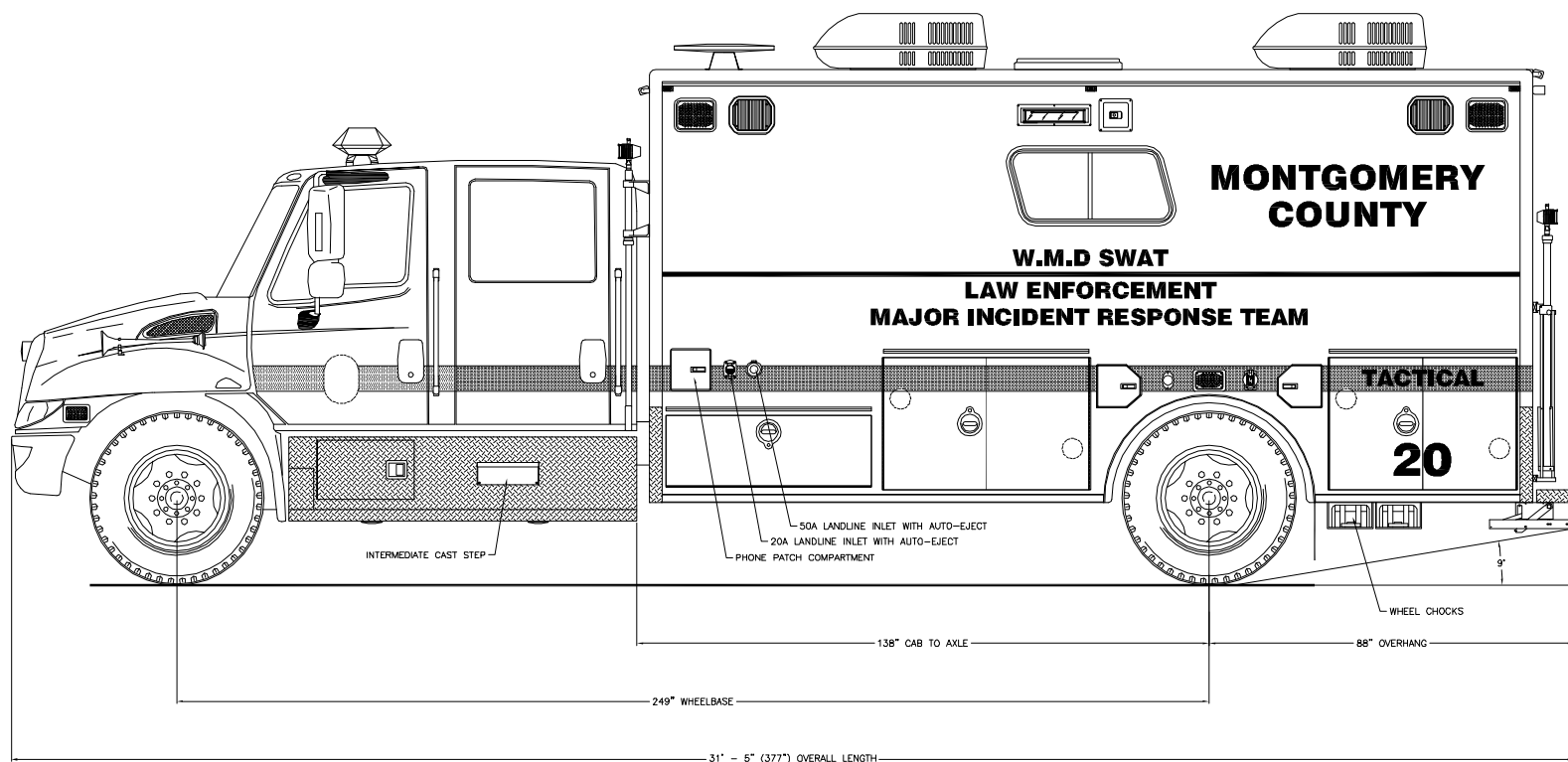

THESE DESIGN/ENGINEERING DRAWING(S) ARE THE PROPERTY OF EMERGENCY VEHICLES, INC. THEY ARE PROPRIETARY, AND ARE FOR THE EXCLUSIVE USE OF YOUR ENTITY. ANY DIVULGING OF THIS DATA TO A THIRD PARTY IS PROHIBITED.

[Signature] DATE: 11/30/05

REVISION 1	NS - 02/23/07
REVISION 2	-
REVISION 3	-
REVISION 4	-
REVISION 5	-

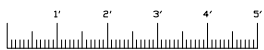

Streetside Overall

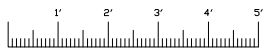
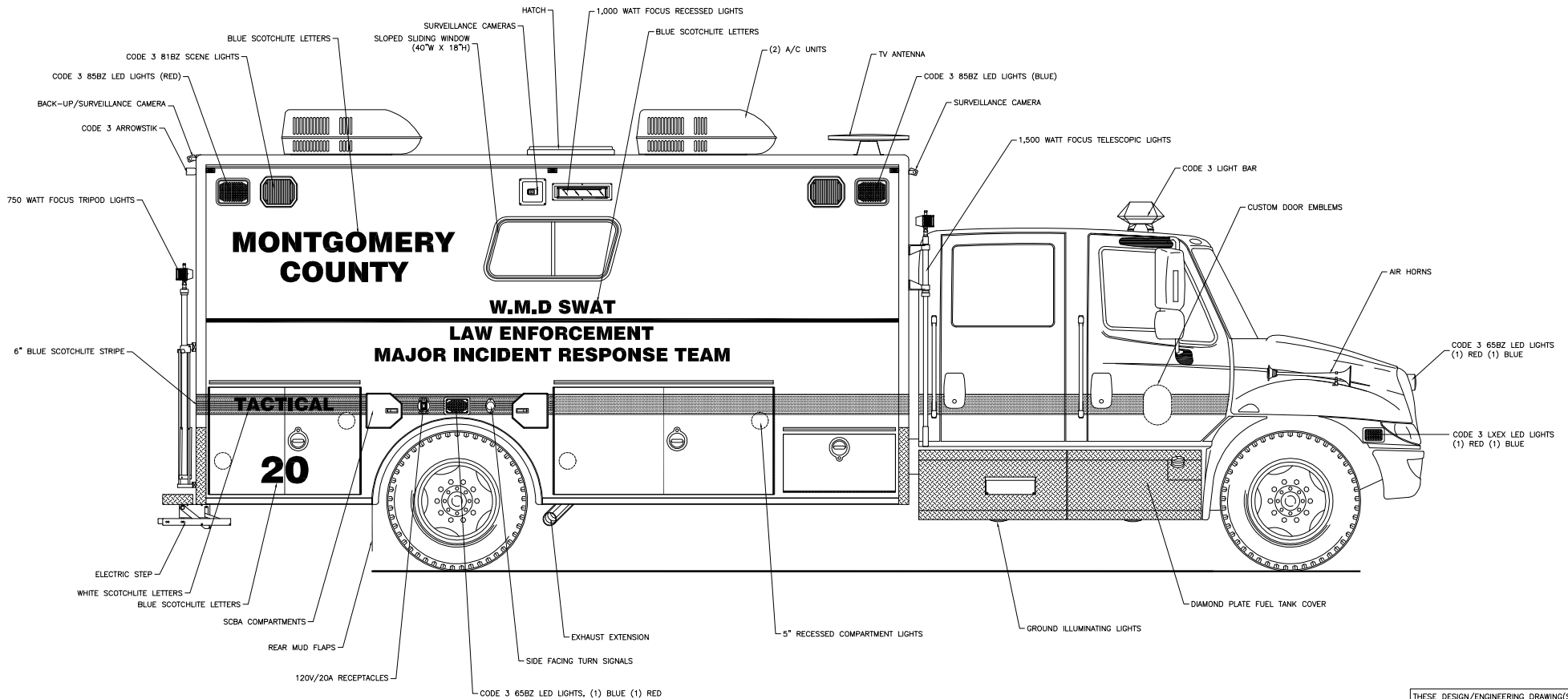

Curbside Overall

THESE DESIGN/ENGINEERING DRAWING(S) ARE THE PROPERTY OF EMERGENCY VEHICLES, INC. THEY ARE PROPRIETARY, AND ARE FOR THE EXCLUSIVE USE OF YOUR ENTITY. ANY DIVULGING OF THIS DATA TO A THIRD PARTY IS PROHIBITED.

[Signature] DATE: 11/30/05

REVISION 1	NS - 02/23/07
REVISION 2	-
REVISION 3	-
REVISION 4	-
REVISION 5	-

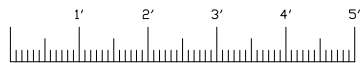
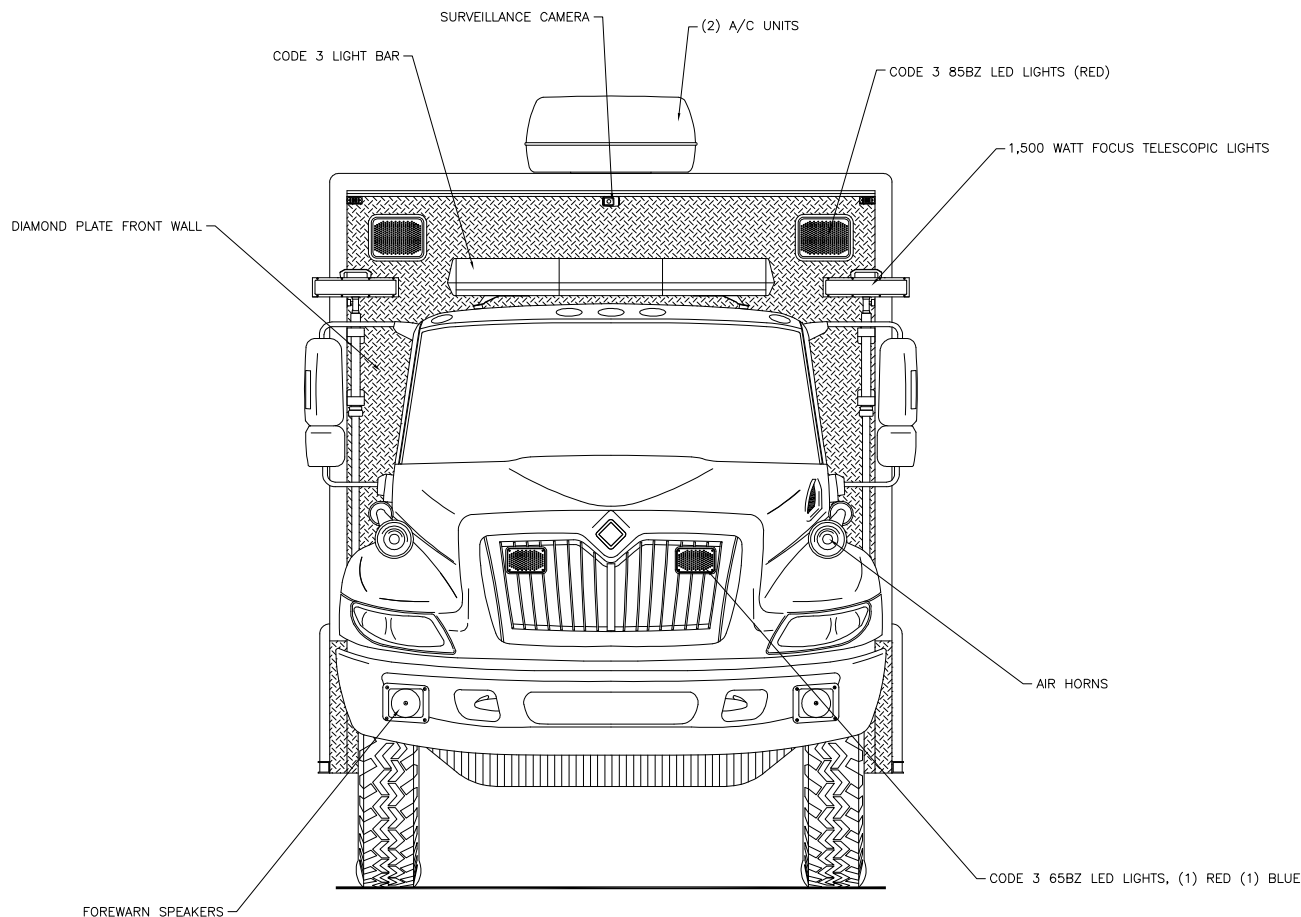

Front View

THESE DESIGN/ENGINEERING DRAWING(S) ARE THE PROPERTY OF EMERGENCY VEHICLES, INC. THEY ARE PROPRIETARY, AND ARE FOR THE EXCLUSIVE USE OF YOUR ENTITY. ANY DIVULGING OF THIS DATA TO A THIRD PARTY IS PROHIBITED.

[Signature] DATE: 11/30/05

REVISION 1	NS - 02/23/07
REVISION 2	-
REVISION 3	-
REVISION 4	-
REVISION 5	-

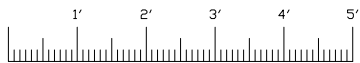
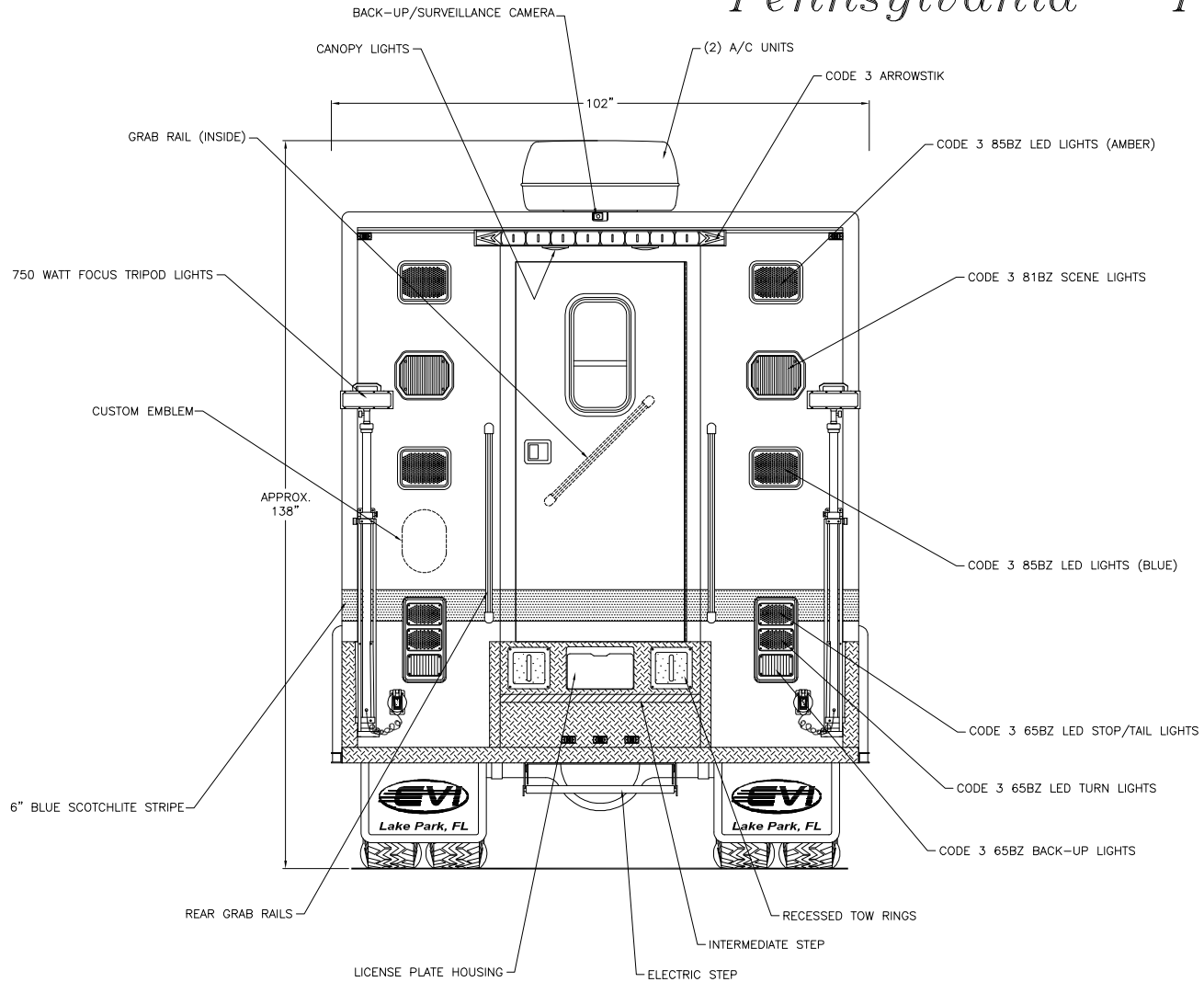

Rear View

THESE DESIGN/ENGINEERING DRAWING(S) ARE THE PROPERTY OF EMERGENCY VEHICLES, INC. THEY ARE PROPRIETARY, AND ARE FOR THE EXCLUSIVE USE OF YOUR ENTITY. ANY DIVULGING OF THIS DATA TO A THIRD PARTY IS PROHIBITED.

		DATE: 11/30/05
REVISION 1	NS - 02/23/07	
REVISION 2	-	
REVISION 3	-	
REVISION 4	-	
REVISION 5	-	