

## West End Fire Rescue Paul, Idaho

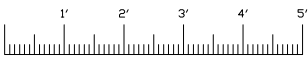
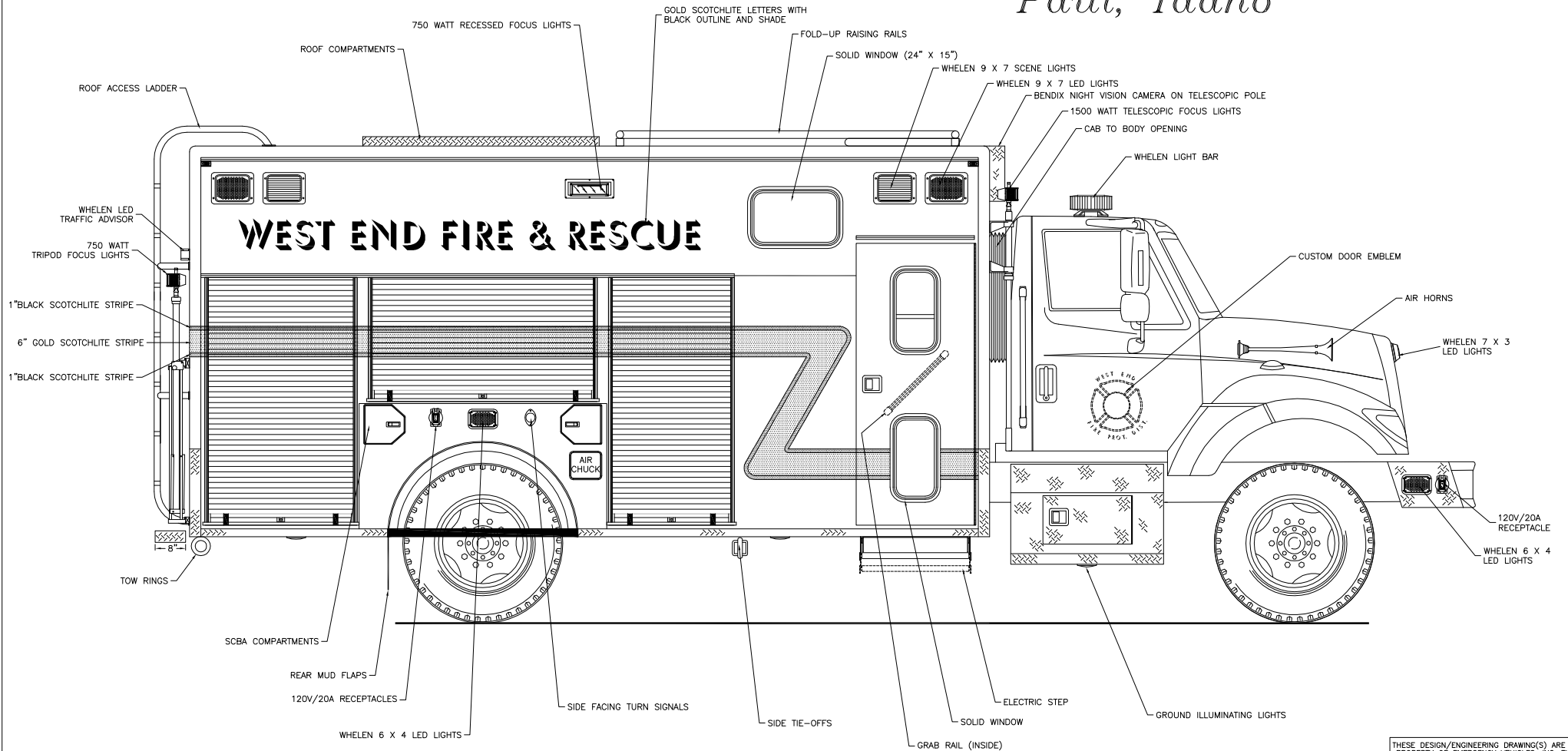

Curbside Overall

THESE DESIGN/ENGINEERING DRAWING(S) ARE THE PROPERTY OF EMERGENCY VEHICLES, INC. THEY ARE PROPRIETARY, AND ARE FOR THE EXCLUSIVE USE OF YOUR ENTITY. ANY DIVULGING OF THIS DATA TO A THIRD PARTY IS PROHIBITED.

		DATE: 03/11/04
REVISION 1		06/17/04
REVISION 2		-
REVISION 3		-
REVISION 4		-
REVISION 5		-

*West End Fire Rescue  
Paul, Idaho*

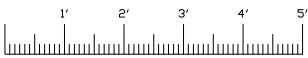
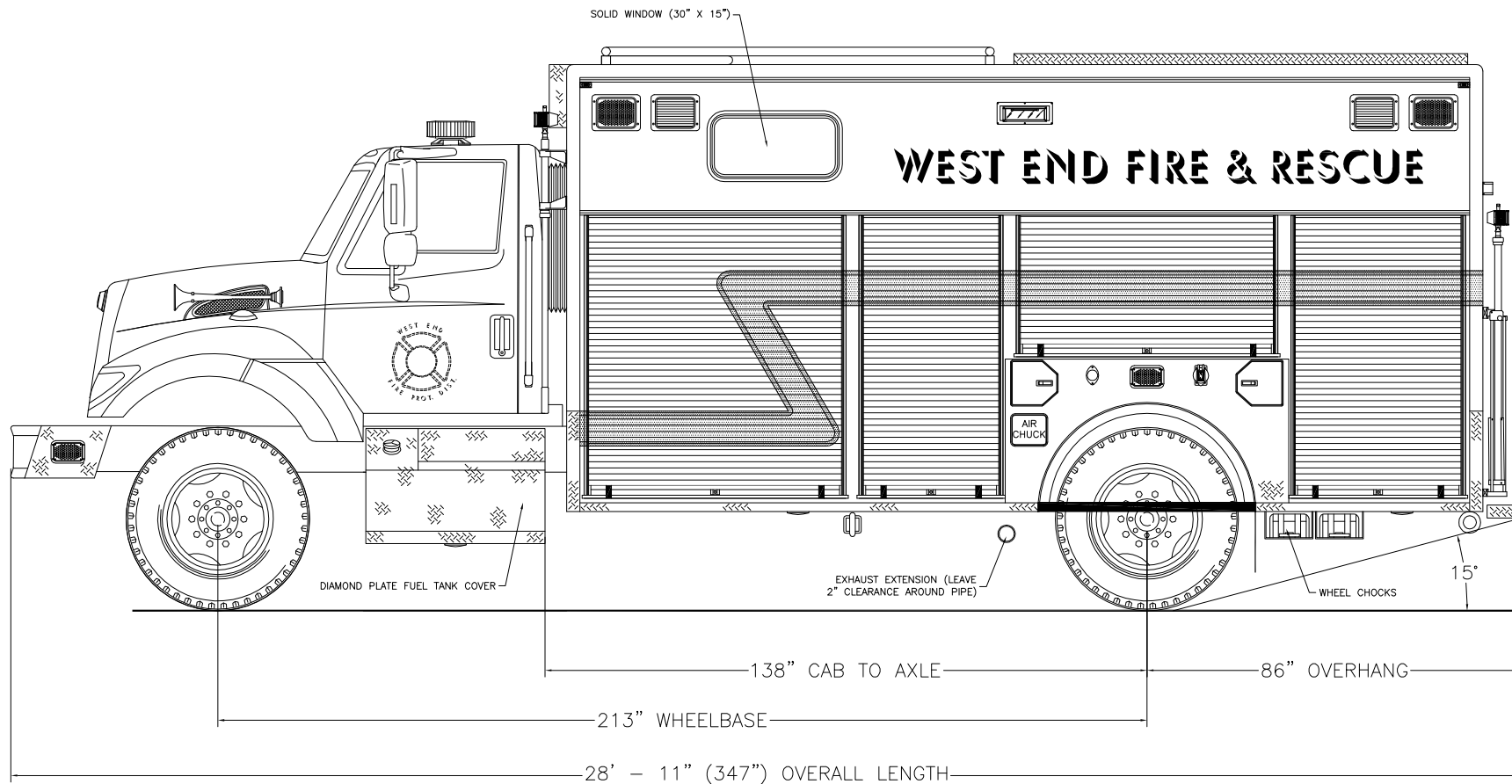

*Streetside Overall*

THESE DESIGN/ENGINEERING DRAWING(S) ARE THE PROPERTY OF EMERGENCY VEHICLES, INC. THEY ARE PROPRIETARY, AND ARE FOR THE EXCLUSIVE USE OF YOUR ENTITY. ANY DIVULGING OF THIS DATA TO A THIRD PARTY IS PROHIBITED.

*[Signature]* DATE: 03/11/04

REVISION 1	06/17/04
REVISION 2	-
REVISION 3	-
REVISION 4	-
REVISION 5	-

*West End Fire Rescue  
Paul, Idaho*

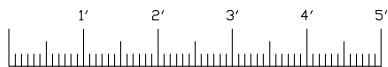
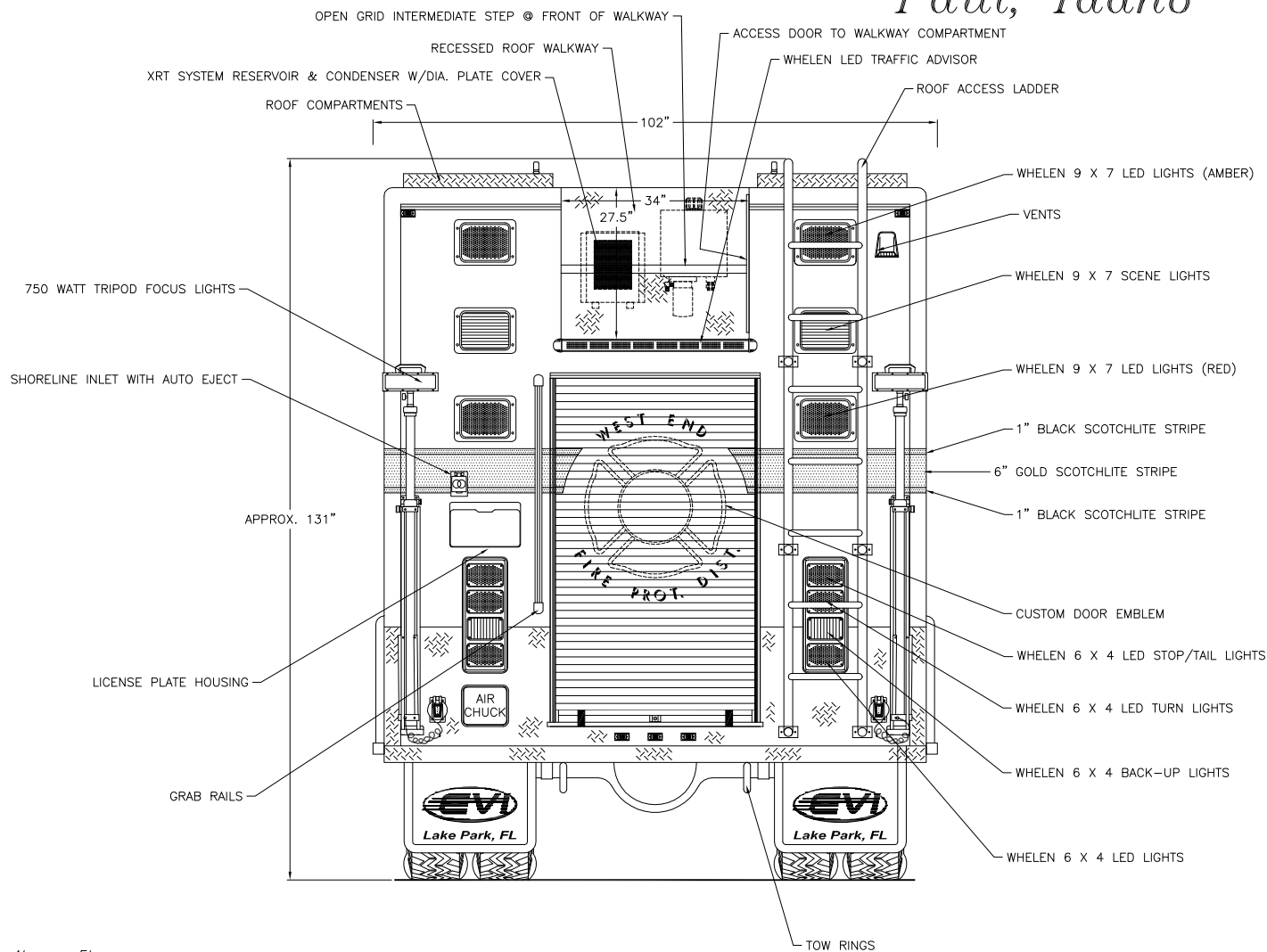

*Rear View*

THESE DESIGN/ENGINEERING DRAWING(S) ARE THE PROPERTY OF EMERGENCY VEHICLES, INC. THEY ARE PROPRIETARY, AND ARE FOR THE EXCLUSIVE USE OF YOUR ENTITY. ANY DIVULGING OF THIS DATA TO A THIRD PARTY IS PROHIBITED.

DATE: 03/11/04	
REVISION 1	06/17/04
REVISION 2	7/22/2004
REVISION 3	-
REVISION 4	-
REVISION 5	-

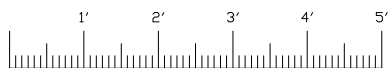
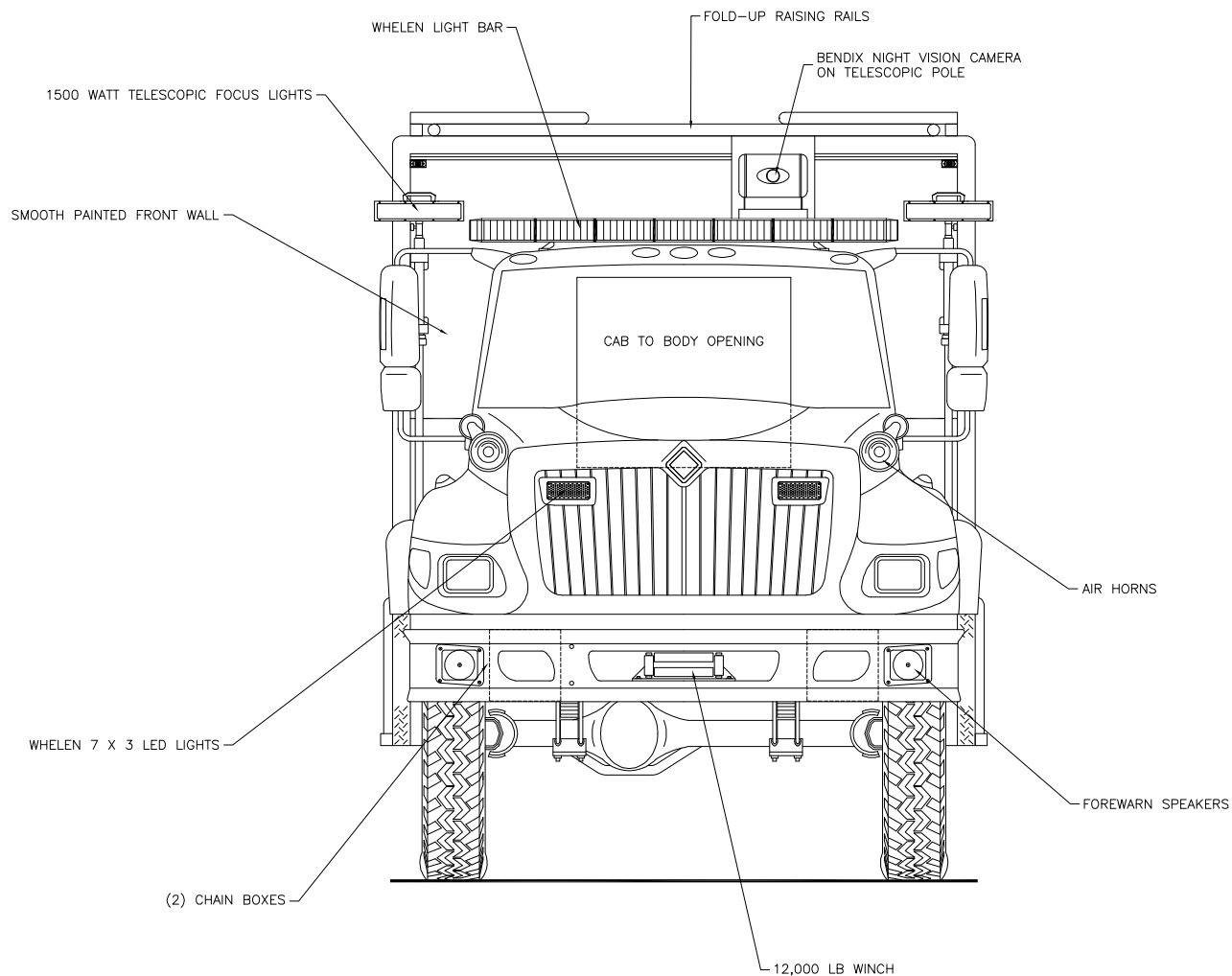

*Front View*

THESE DESIGN/ENGINEERING DRAWING(S) ARE THE PROPERTY OF EMERGENCY VEHICLES, INC. THEY ARE PROPRIETARY, AND ARE FOR THE EXCLUSIVE USE OF YOUR ENTITY. ANY DIVULGING OF THIS DATA TO A THIRD PARTY IS PROHIBITED.

*[Signature]* DATE: 03/11/04

REVISION 1	06/17/04
REVISION 2	-
REVISION 3	-
REVISION 4	-
REVISION 5	-