

EMERGENCY VEHICLES, INC.

*Highlands Fire Rescue
Highlands, North Carolina*

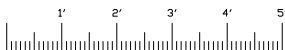
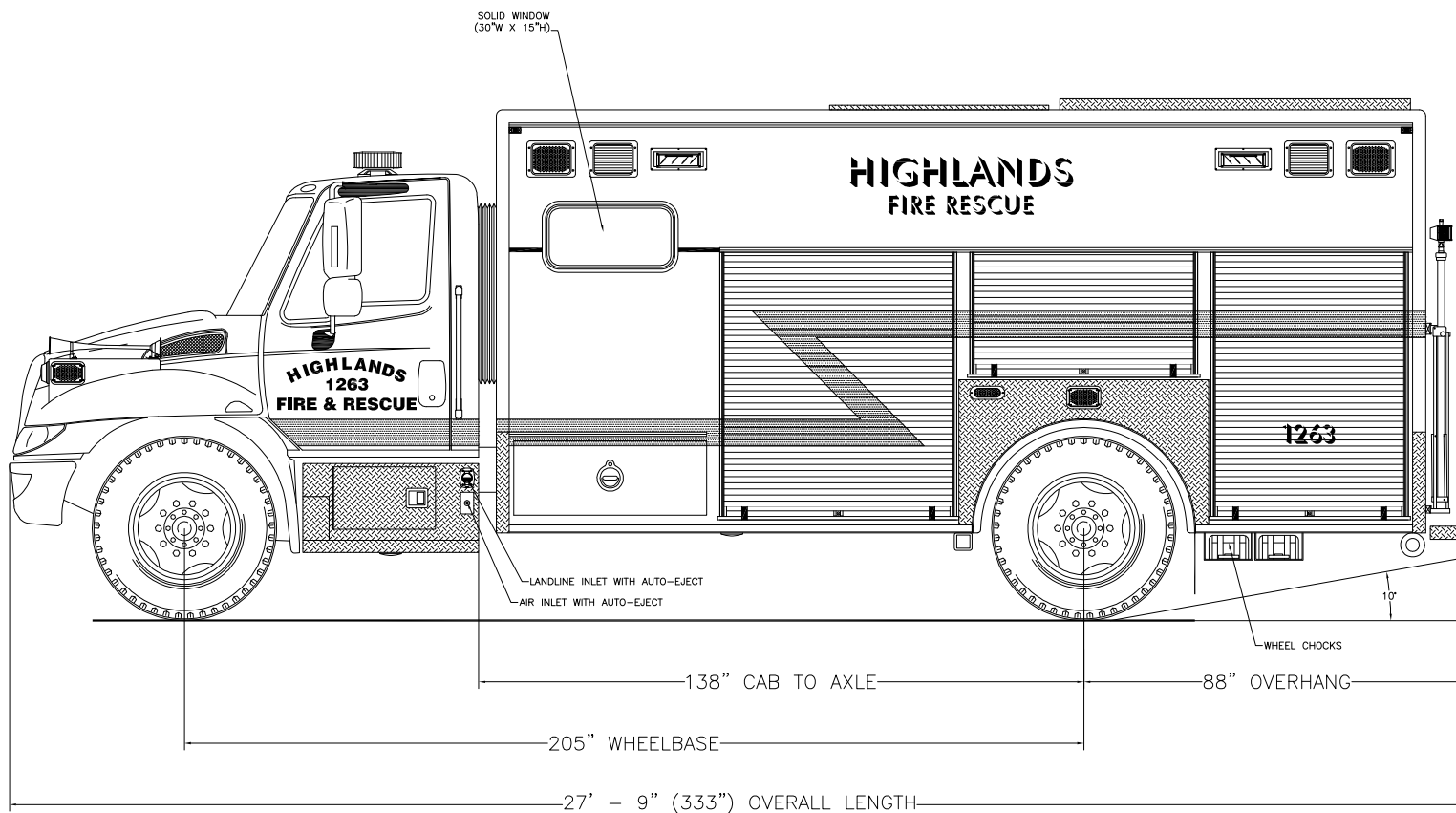

Streetside Overall

THESE DESIGN/ENGINEERING DRAWING(S) ARE THE PROPERTY OF EMERGENCY VEHICLES, INC. THEY ARE PROPRIETARY, AND ARE FOR THE EXCLUSIVE USE OF YOUR ENTITY. ANY DIVULGING OF THIS DATA TO A THIRD PARTY IS PROHIBITED.

E.V. Inc. DATE: 02/20/07

REVISION 1	NS - 05/21/07
REVISION 2	NS - 09/14/07
REVISION 3	NS - 10/16/07
REVISION 4	-
REVISION 5	-

*Highlands Fire Rescue
Highlands, North Carolina*

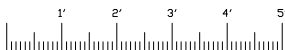
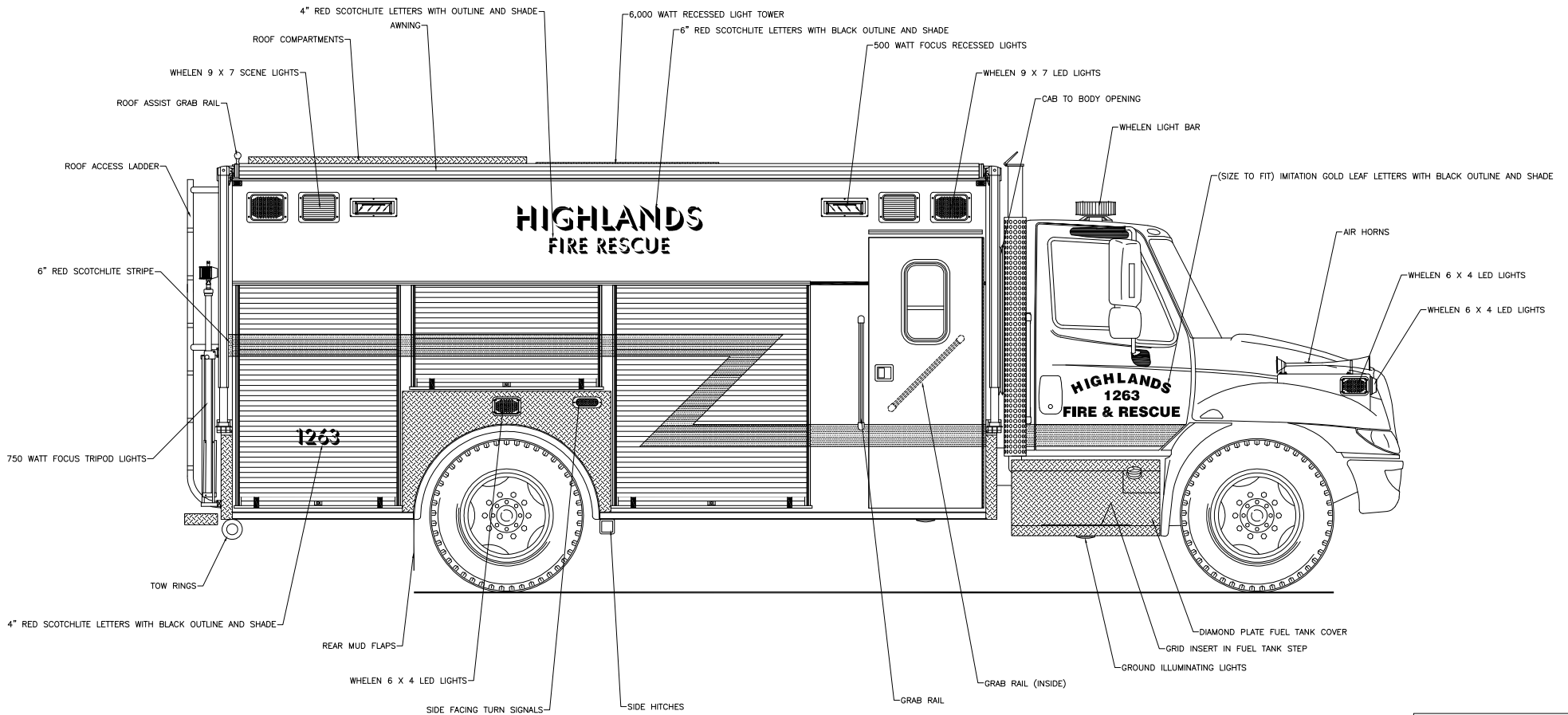

Curbside Overall

THESE DESIGN/ENGINEERING DRAWING(S) ARE THE PROPERTY OF EMERGENCY VEHICLES, INC. THEY ARE PROPRIETARY, AND ARE FOR THE EXCLUSIVE USE OF YOUR ENTITY. ANY DIVULGING OF THIS DATA TO A THIRD PARTY IS PROHIBITED.

		DATE: 02/20/07
REVISION 1	NS - 05/21/07	
REVISION 2	NS - 09/14/07	
REVISION 3	NS - 10/16/07	
REVISION 4	-	
REVISION 5	-	

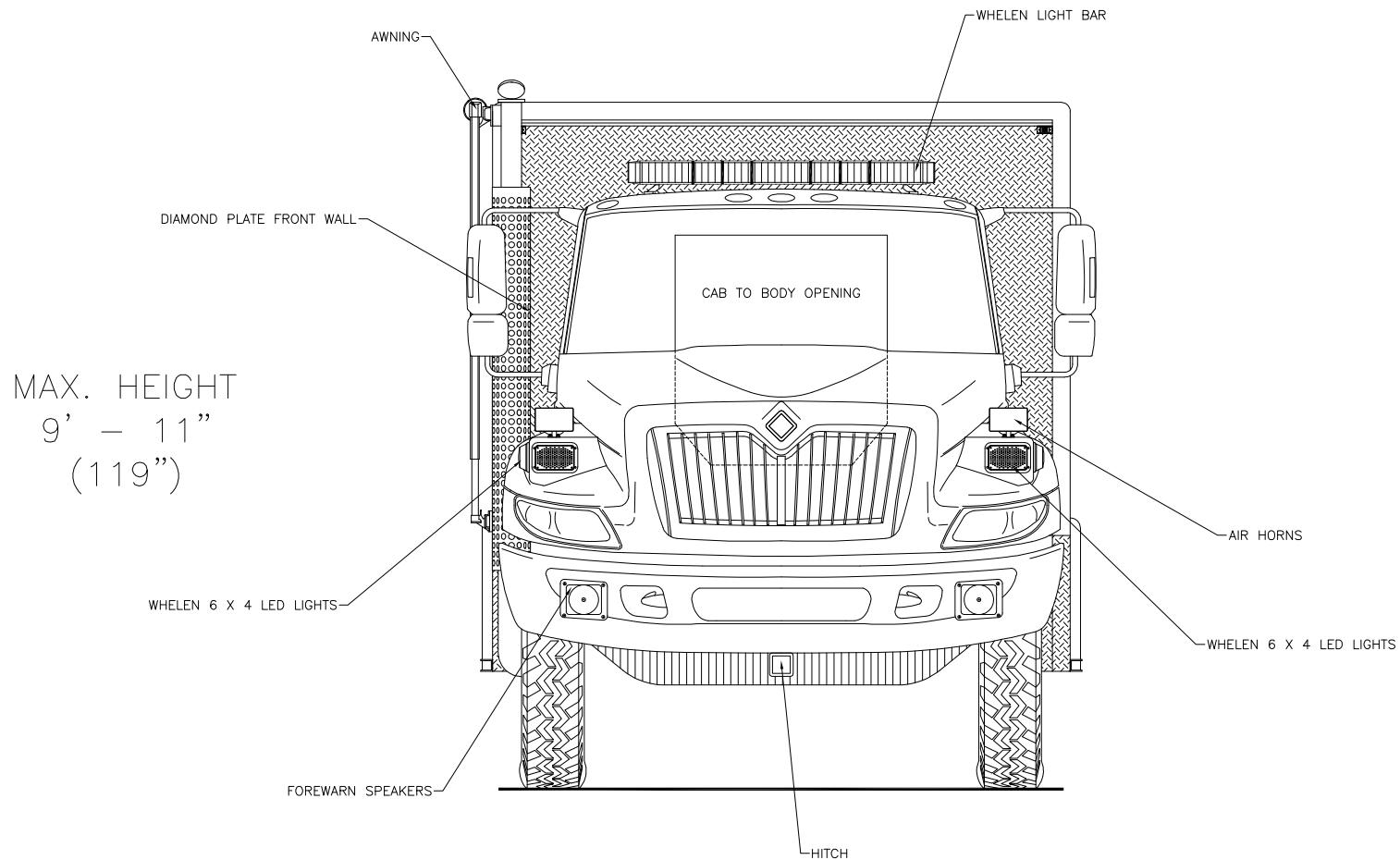

MAX. HEIGHT
9' - 11"
(119")

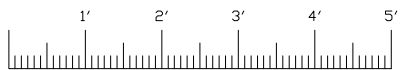

Front View

THESE DESIGN/ENGINEERING DRAWING(S) ARE THE PROPERTY OF EMERGENCY VEHICLES, INC. THEY ARE PROPRIETARY, AND ARE FOR THE EXCLUSIVE USE OF YOUR ENTITY. ANY DIVULGING OF THIS DATA TO A THIRD PARTY IS PROHIBITED.

E.V. Inc. DATE: 02/20/07

REVISION 1	NS - 05/21/07
REVISION 2	NS - 09/14/07
REVISION 3	NS - 10/16/07
REVISION 4	-
REVISION 5	-

*Highlands Fire Rescue
Highlands, North Carolina*

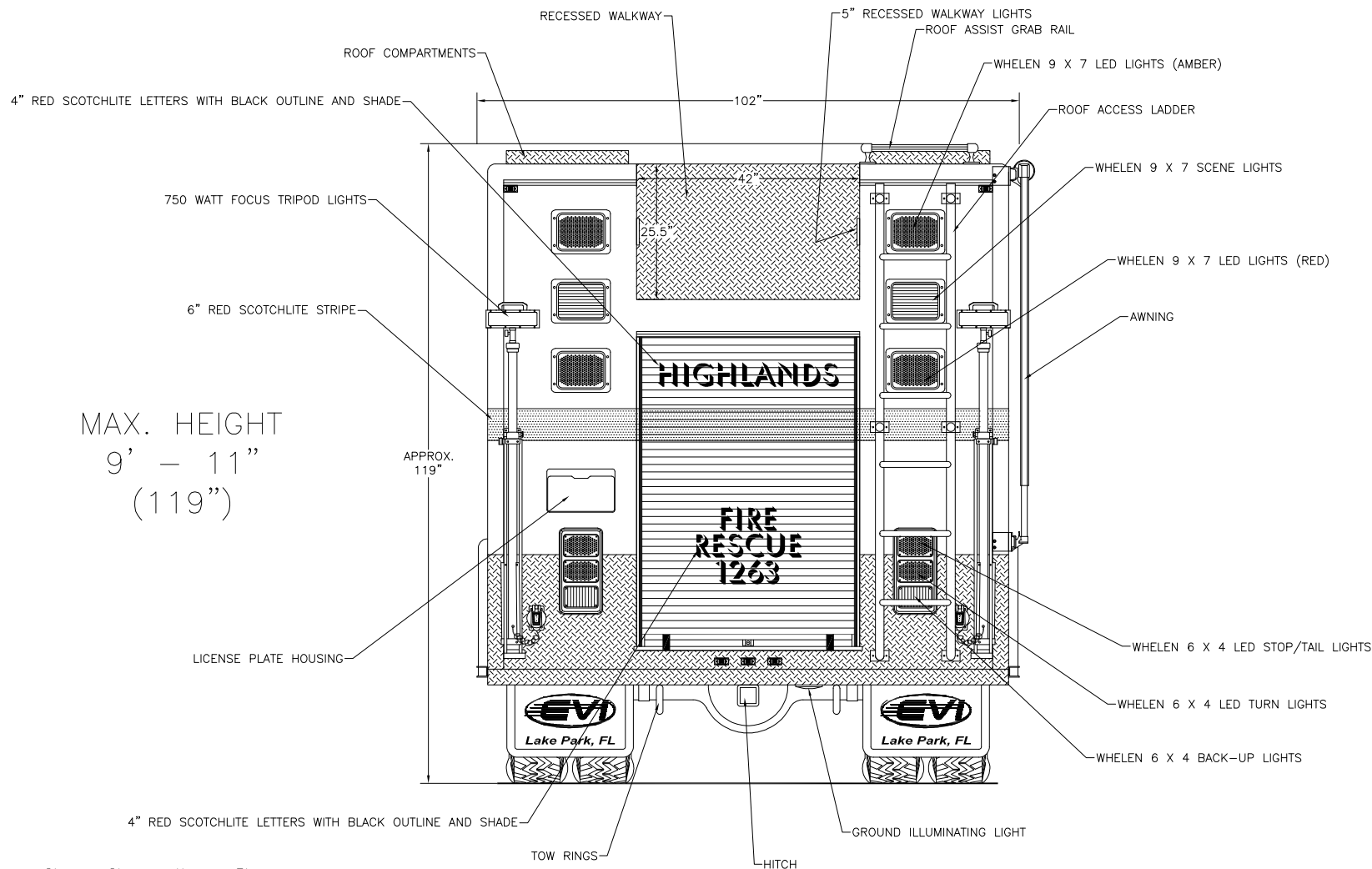

MAX. HEIGHT
9' - 11"
(119")

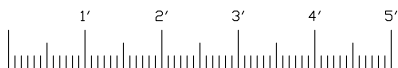

Rear View

THESE DESIGN/ENGINEERING DRAWING(S) ARE THE PROPERTY OF EMERGENCY VEHICLES, INC. THEY ARE PROPRIETARY, AND ARE FOR THE EXCLUSIVE USE OF YOUR ENTITY. ANY DIVULGING OF THIS DATA TO A THIRD PARTY IS PROHIBITED.

<i>E.V. Inc.</i> DATE: 02/20/07	
REVISION 1	NS - 05/21/07
REVISION 2	NS - 09/14/07
REVISION 3	NS - 10/16/07
REVISION 4	-
REVISION 5	-