

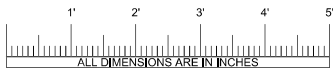

705 13TH STREET, LAKE PARK, FL  
800-848-6652

City Of Austin Police Department  
Austin, Texas

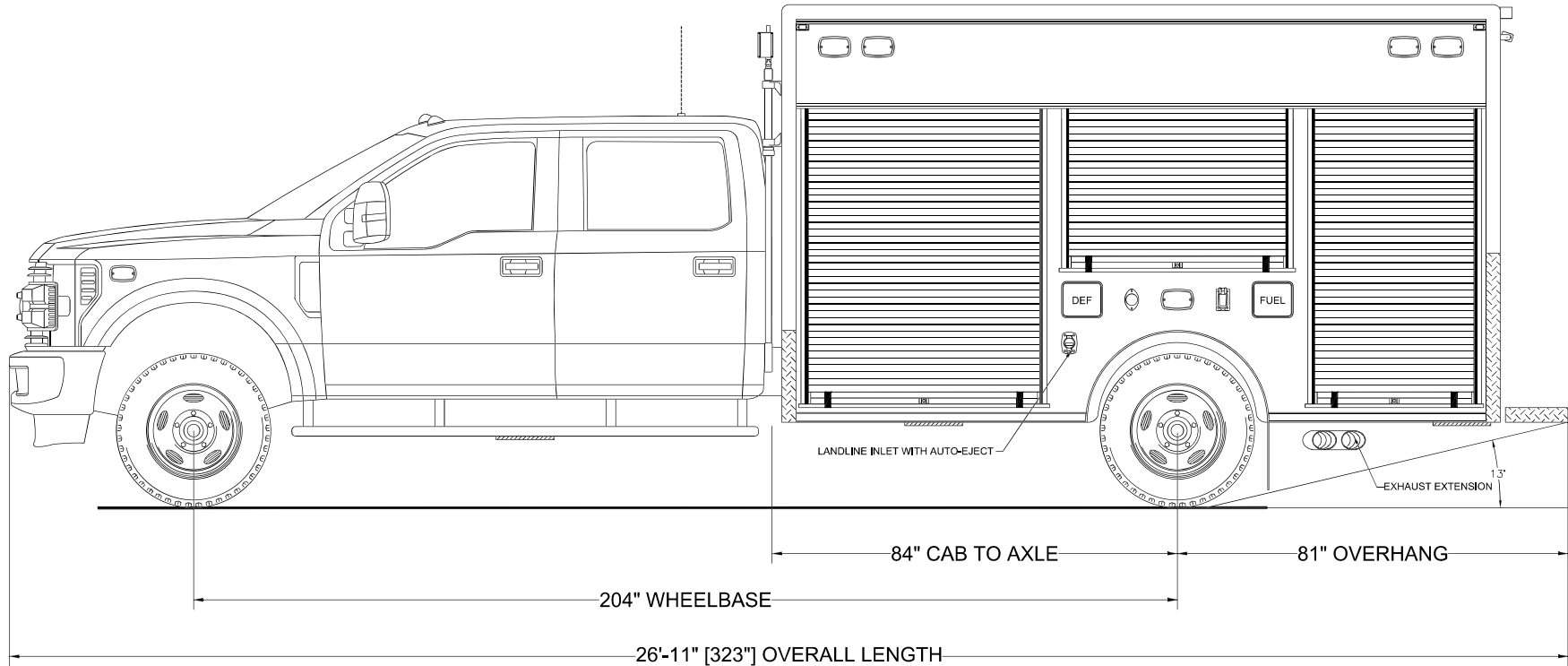

ALL DIMENSIONS ARE IN INCHES

Streetside Overall

NOTICE

THIS DRAWING IS A REPRESENTATION OF THE VEHICLE AND/OR COMPONENTS AS DESCRIBED IN THE SPECIFICATIONS FOR THE DATE SHOWN. EVI RESERVES THE RIGHT TO MAKE CHANGES, AS NECESSARY, DURING THE PRODUCTION PROCESS TO ACCOMMODATE BEST MANUFACTURING PROCESSES AND TO ENSURE WE PROVIDE A CONSISTENTLY HIGH QUALITY PRODUCT.

REVISION 1	NS - 11/29/21
REVISION 2	NS - 05/05/22 - ADD#1
REVISION 3	-
REVISION 4	-
REVISION 5	-
REVISION 6	-

THESE DESIGN/ENGINEERING DRAWING(S) ARE THE PROPERTY OF EMERGENCY VEHICLES, INC. THEY ARE PROPRIETARY, AND ARE FOR THE EXCLUSIVE USE OF YOUR DEPT. ANY DIVULGING OF THIS DRAWING TO A THIRD PARTY IS PROHIBITED.

DATE: 11/23/21



705 13TH STREET, LAKE PARK, FL  
800-848-6652

# City Of Austin Police Department Austin, Texas

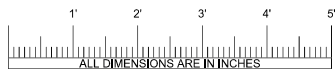
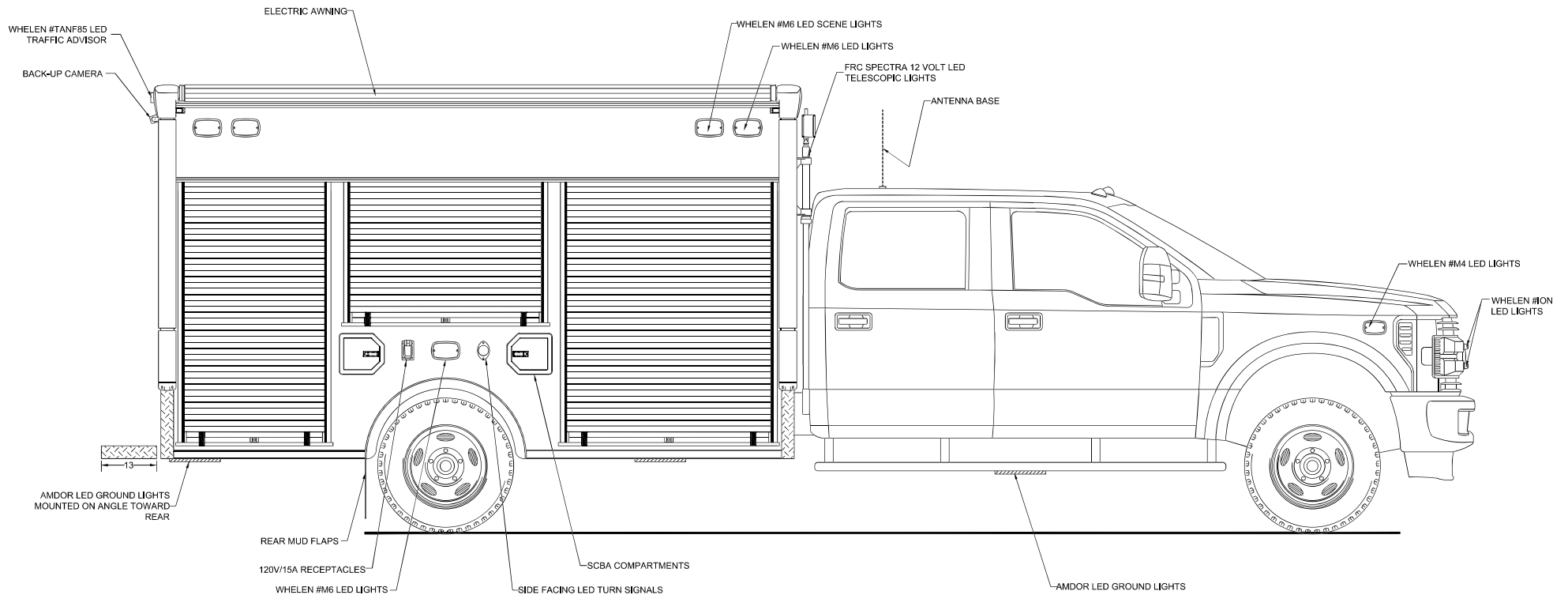

Curbside Overall

NOTICE	
THIS DRAWING IS A REPRESENTATION OF THE VEHICLE AND/OR COMPONENTS AS DESCRIBED IN THE SPECIFICATIONS FOR THE DATE SHOWN. EVI RESERVES THE RIGHT TO MAKE CHANGES, AS NECESSARY, DURING THE PRODUCTION PROCESS TO ACCOMMODATE BEST MANUFACTURING PROCESSES AND TO ENSURE WE PROVIDE A CONSISTENTLY HIGH QUALITY PRODUCT.	
REVISION 1	NS - 11/29/21
REVISION 2	NS - 05/05/22 - ADD#1
REVISION 3	-
REVISION 4	-
REVISION 5	-
REVISION 6	-

THESE DESIGN/ENGINEERING DRAWING(S) ARE THE PROPERTY OF EMERGENCY VEHICLES, INC. THEY ARE PROPRIETARY, AND ARE FOR THE EXCLUSIVE USE OF YOUR PARTY. ANY DIVULGING OF THIS DRAWING TO A THIRD PARTY IS PROHIBITED.

*[Signature]* DATE: 11/23/21



705 13TH STREET, LAKE PARK, FL  
800-848-6652

City Of Austin Police Department  
Austin, Texas

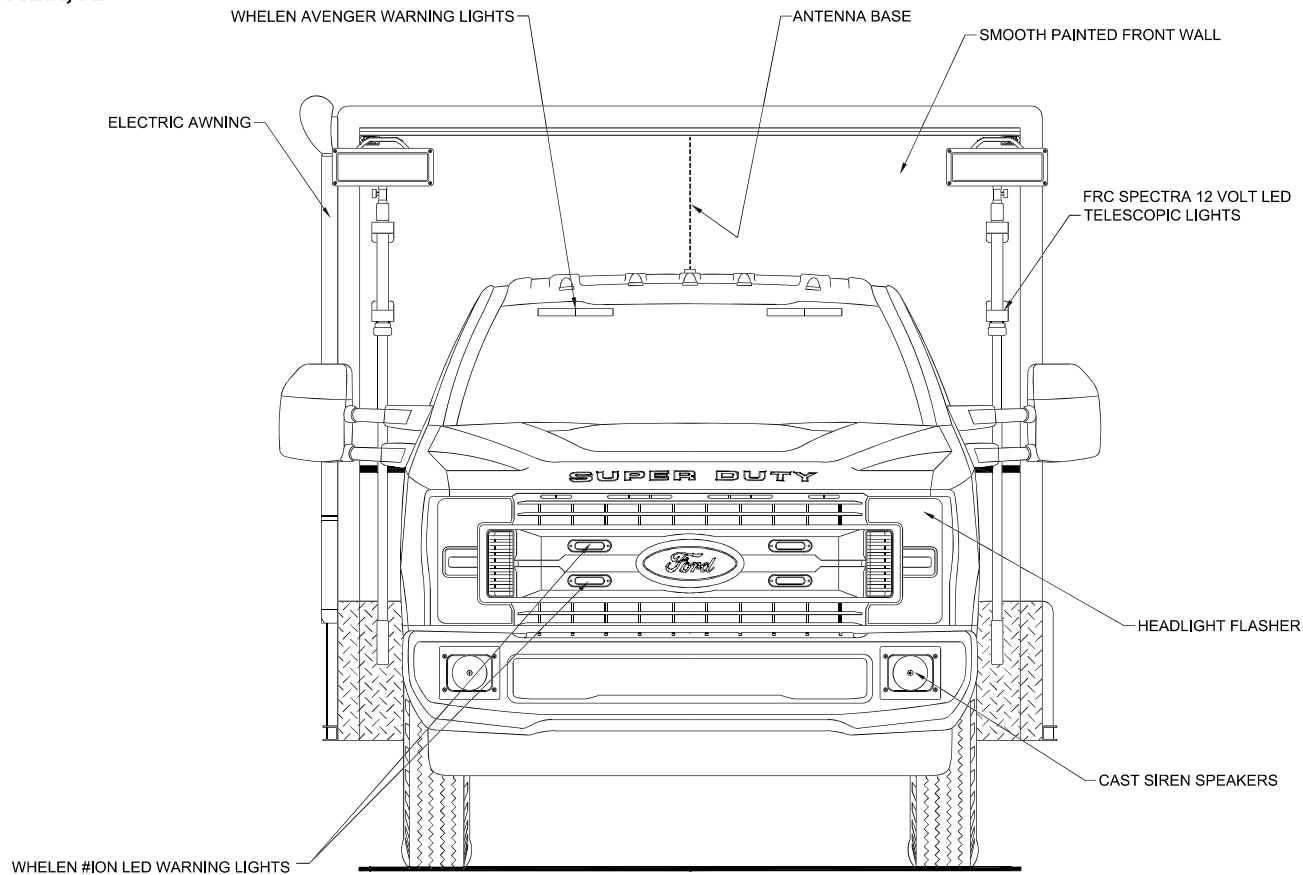

Front View

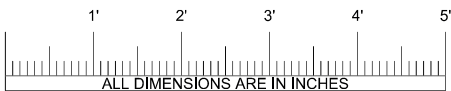

NOTICE

THIS DRAWING IS A REPRESENTATION OF THE VEHICLE AND/OR COMPONENTS AS DESCRIBED IN THE SPECIFICATIONS FOR THE DATE SHOWN. EVI RESERVES THE RIGHT TO MAKE CHANGES, AS NECESSARY, DURING THE PRODUCTION PROCESS TO ACCOMMODATE BEST MANUFACTURING PROCESSES AND TO ENSURE WE PROVIDE A CONSISTENTLY HIGH QUALITY PRODUCT.

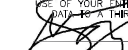
REVISION 1	NS - 11/29/21	THESE DESIGN/ENGINEERING DRAWING(S) ARE THE PROPERTY OF EMERGENCY VEHICLES, INC. THEY ARE PROPRIETARY, AND ARE FOR THE EXCLUSIVE USE OF YOUR DEPARTMENT. ANY DIVULGING OF THIS DATA TO A THIRD PARTY IS PROHIBITED. 
REVISION 2	NS - 05/05/22 - ADD#1	
REVISION 3	-	
REVISION 4	-	
REVISION 5	-	
REVISION 6	-	

DATE: 11/23/21



705 13TH STREET, LAKE PARK, FL  
800-848-6652

City Of Austin Police Department  
Austin, Texas

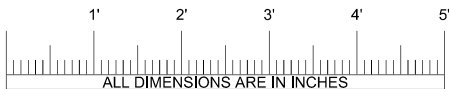
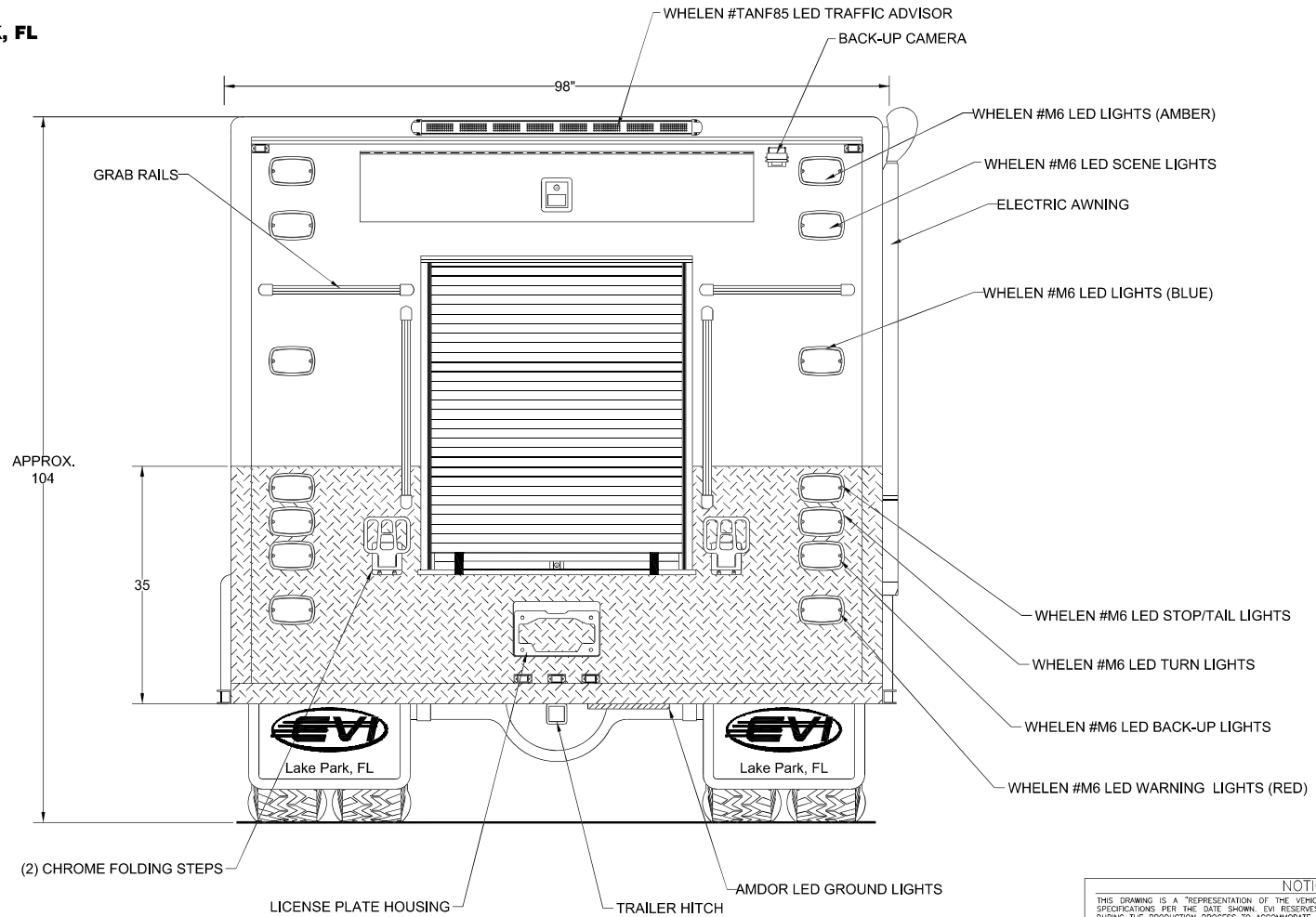

Rear View

NOTICE	
THIS DRAWING IS A REPRESENTATION OF THE VEHICLE AND/OR COMPONENTS AS DESCRIBED IN THE SPECIFICATIONS FOR THE DATE SHOWN. EVI RESERVES THE RIGHT TO MAKE CHANGES, AS NECESSARY, DURING THE PRODUCTION PROCESS TO ACCOMMODATE BEST MANUFACTURING PROCESSES AND TO ENSURE WE PROVIDE A CONSISTENTLY HIGH QUALITY PRODUCT.	
REVISION 1	NS - 11/29/21
REVISION 2	NS - 05/05/22 - ADD#1
REVISION 3	-
REVISION 4	-
REVISION 5	-
REVISION 6	-

THESE DESIGN/ENGINEERING DRAWING(S) ARE THE PROPERTY OF EMERGENCY VEHICLES, INC. THEY ARE PROPRIETARY, AND ARE FOR THE EXCLUSIVE USE OF YOUR PARTY. ANY DIVULGING OF THIS DRAWING TO A THIRD PARTY IS PROHIBITED.

DATE: 11/23/21