

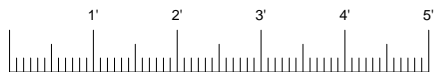

705 13TH STREET, LAKE PARK, FL  
800-848-6652

*Pompano Beach Fire Rescue  
Pompano Beach, Florida*

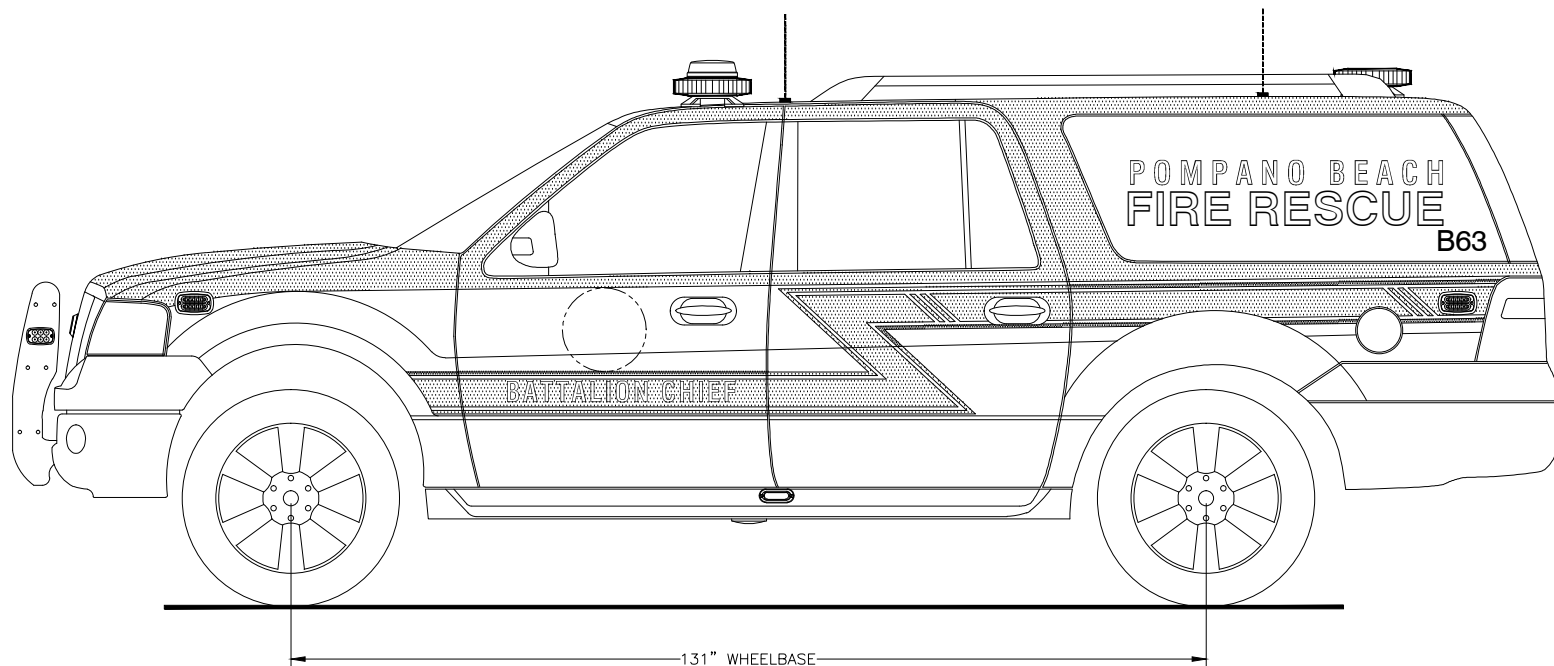

*Streetside Overall*

THESE DESIGN/ENGINEERING DRAWING(S) ARE THE PROPERTY OF EMERGENCY VEHICLES, INC. THEY ARE PROPRIETARY, AND ARE FOR THE EXCLUSIVE USE OF YOUR ENTITY. ANY DIVULGING OF THIS DATA TO A THIRD PARTY IS PROHIBITED.

*[Signature]* DATE: 04/01/13

REVISION 1	ACS - 06/06/13
REVISION 2	-
REVISION 3	-
REVISION 4	-
REVISION 5	-



705 13TH STREET, LAKE PARK, FL  
800-848-6652

# Pompano Beach Fire Rescue Pompano Beach, Florida

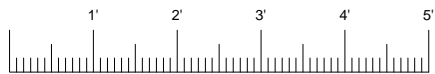
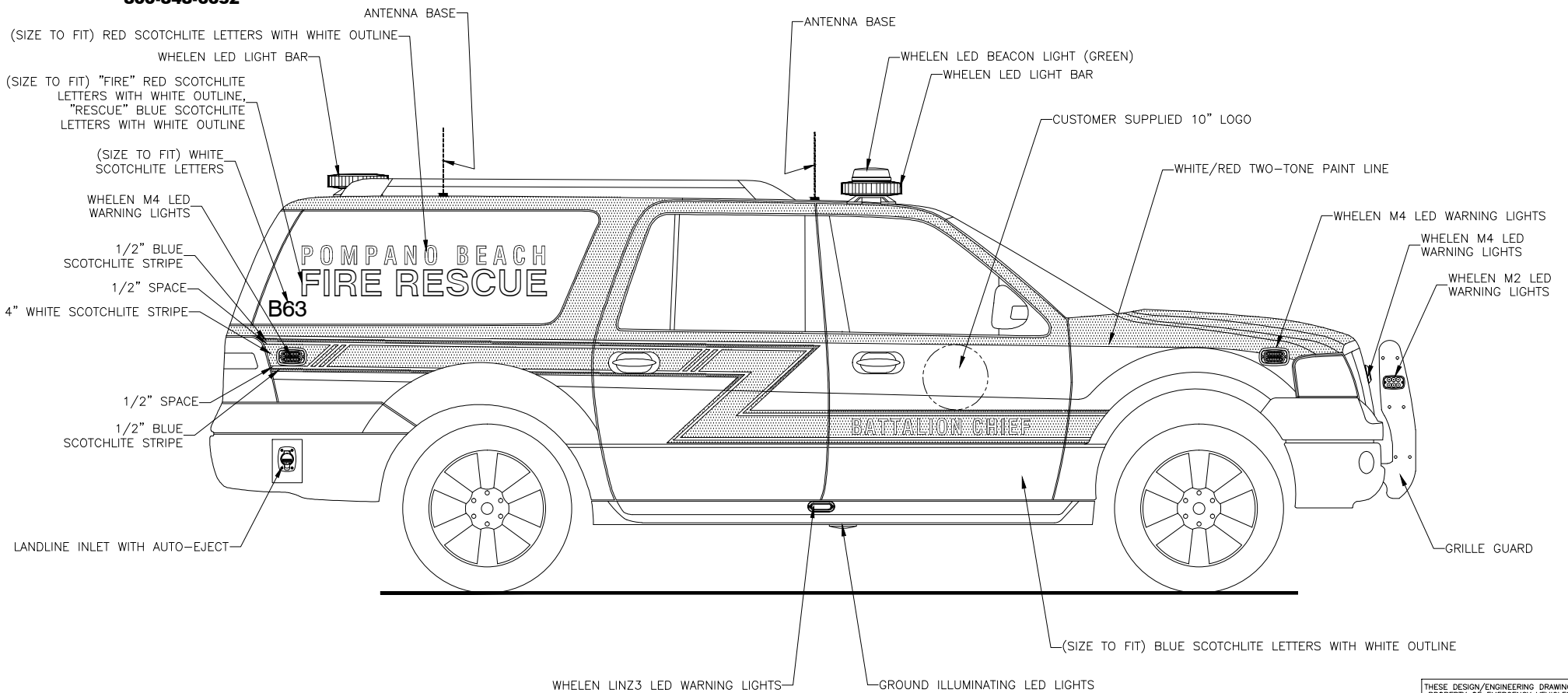

Curbside Overall

THESE DESIGN/ENGINEERING DRAWING(S) ARE THE PROPERTY OF EMERGENCY VEHICLES, INC. THEY ARE PROPRIETARY, AND ARE FOR THE EXCLUSIVE USE OF YOUR ENTITY. ANY DIVULGING OF THIS DATA TO A THIRD PARTY IS PROHIBITED.

DATE:	04/01/13
REVISION 1	ACS - 06/06/13
REVISION 2	-
REVISION 3	-
REVISION 4	-
REVISION 5	-



705 13TH STREET, LAKE PARK, FL  
800-848-6652

*Pompano Beach Fire Rescue  
Pompano Beach, Florida*

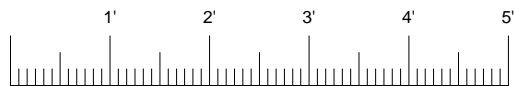
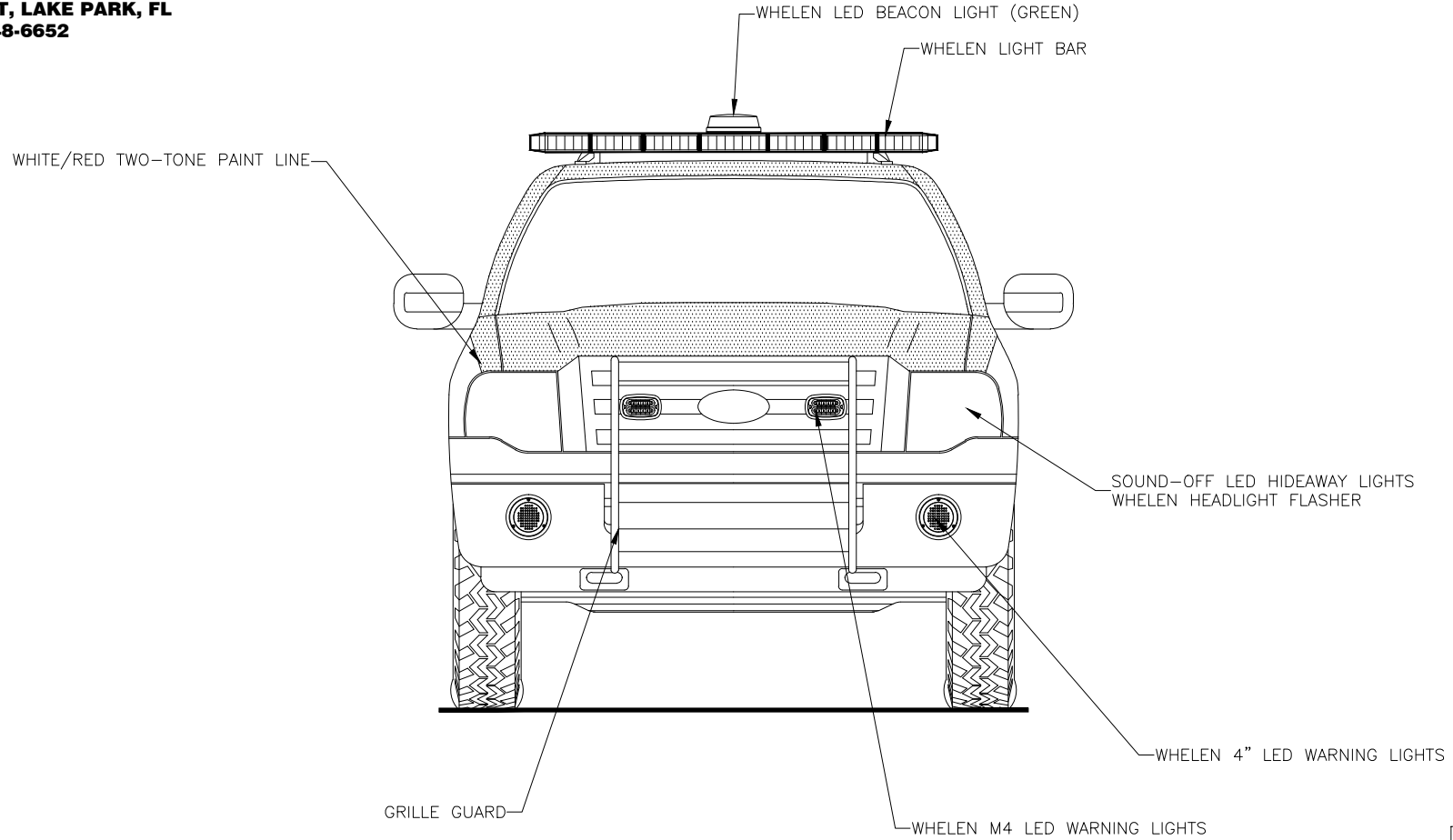

*Front View*

THESE DESIGN/ENGINEERING DRAWING(S) ARE THE PROPERTY OF EMERGENCY VEHICLES, INC. THEY ARE PROPRIETARY, AND ARE FOR THE EXCLUSIVE USE OF YOUR ENTITY. ANY DIVULGING OF THIS DATA TO A THIRD PARTY IS PROHIBITED.

*[Signature]* DATE: 04/01/13

REVISION 1	ACS - 06/06/13
REVISION 2	-
REVISION 3	-
REVISION 4	-
REVISION 5	-



705 13TH STREET, LAKE PARK, FL  
800-848-6652

*Pompano Beach Fire Rescue  
Pompano Beach, Florida*

(SIZE TO FIT) "FIRE" RED SCOTCHLITE  
LETTERS WITH WHITE OUTLINE,  
"RESCUE" BLUE SCOTCHLITE  
LETTERS WITH WHITE OUTLINE

(SIZE TO FIT) WHITE  
SCOTCHLITE LETTERS

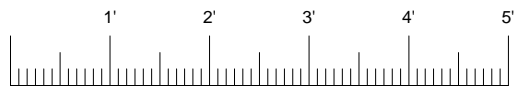
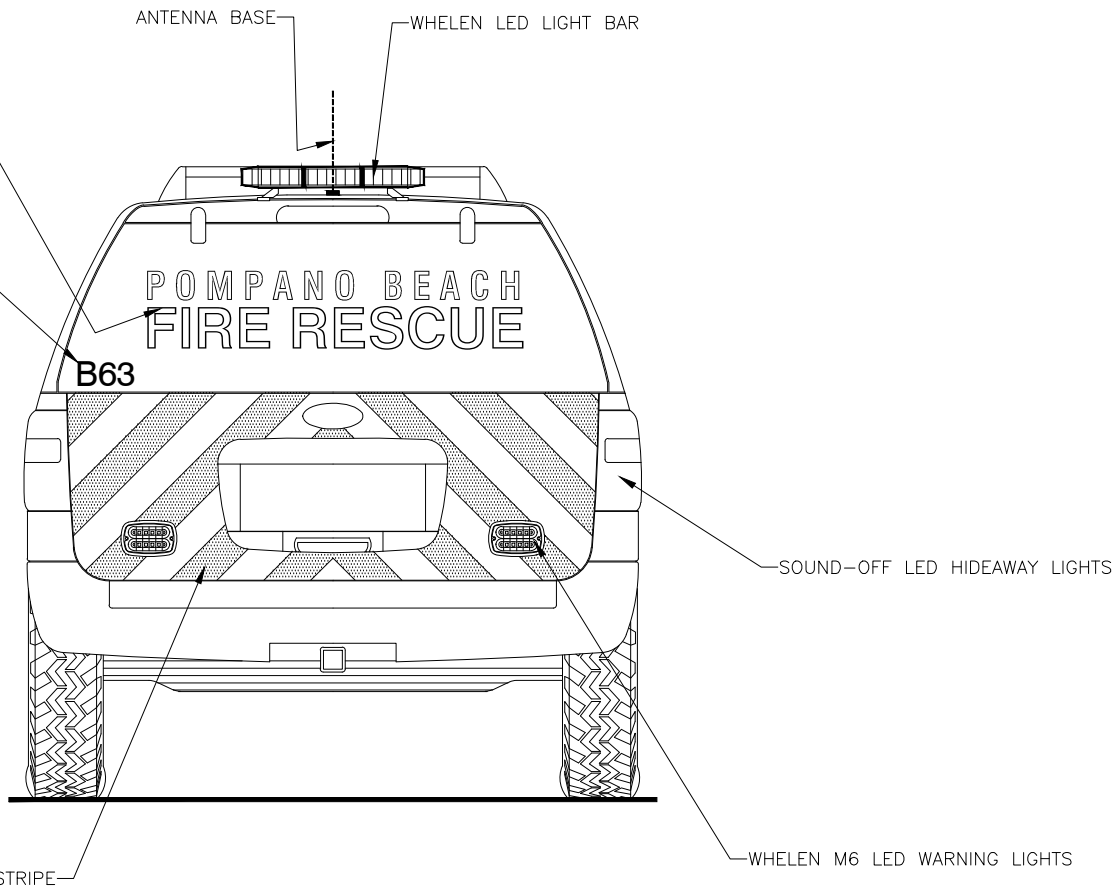

*Rear View*

THESE DESIGN/ENGINEERING DRAWING(S) ARE THE  
PROPERTY OF EMERGENCY VEHICLES, INC. THEY  
ARE PROPRIETARY, AND ARE FOR THE EXCLUSIVE  
USE OF YOUR ENTITY. ANY DIVULGING OF THIS  
DATA TO A THIRD PARTY IS PROHIBITED.

		DATE: 04/01/13
REVISION 1	ACS	06/06/13
REVISION 2	-	-
REVISION 3	-	-
REVISION 4	-	-
REVISION 5	-	-