

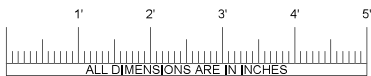

705 13TH STREET, LAKE PARK, FL  
800-848-6652

# Kern County Bakersfield, California

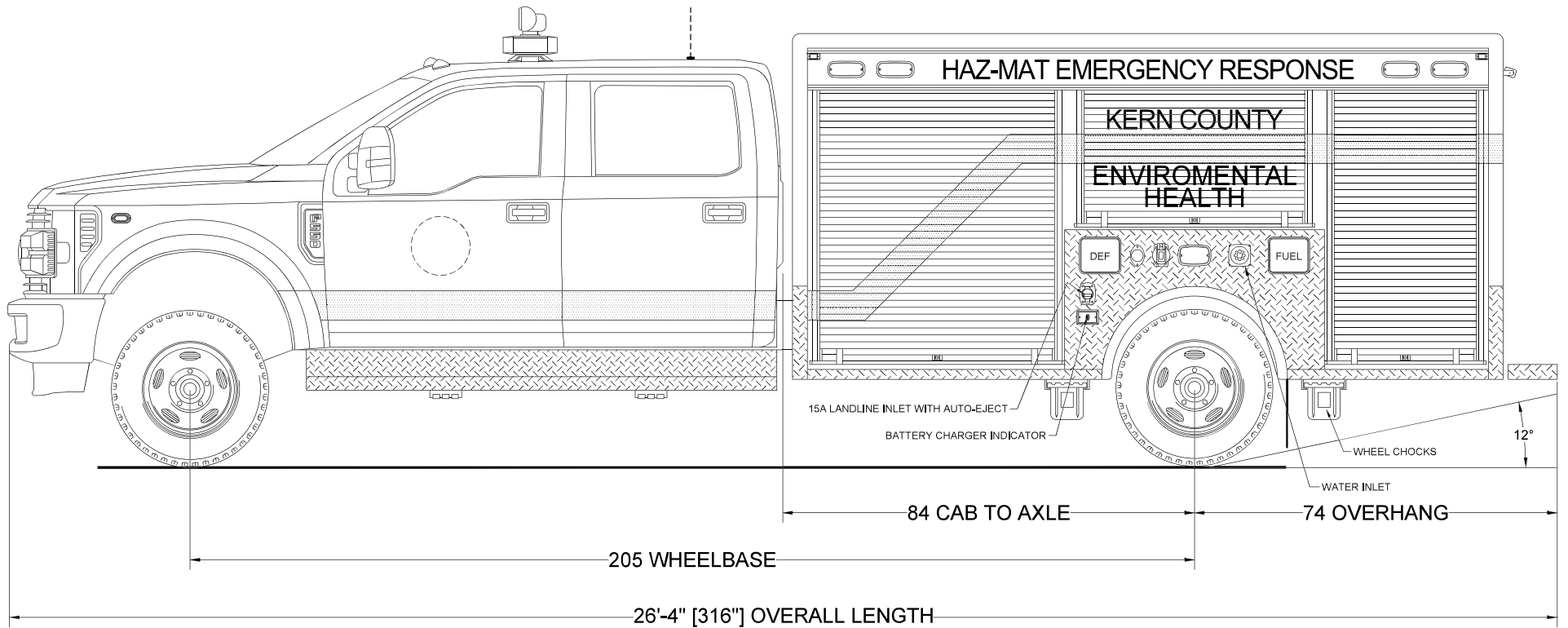

## Streetside Overall

### PRODUCTION

**NOTICE:** THIS DRAWING IS A REPRESENTATION OF THE VEHICLE AND/OR COMPONENTS AS DESCRIBED IN THE SPECIFICATIONS FOR THE DATE SHOWN. EVI RESERVES THE RIGHT TO MAKE CHANGES AS NECESSARY DURING THE PRODUCTION PROCESS TO ACCOMMODATE BEST MANUFACTURING PROCESSES AND TO ENSURE WE PROVIDE A CONSISTENTLY HIGH QUALITY PRODUCT.

REVISION 1	NS - 02/24/23 PR	THESE DESIGN/ENGINEERING DRAWING(S) ARE THE PROPERTY OF EMERGENCY VEHICLES, INC. THEY ARE PROPRIETARY AND ARE FOR THE EXCLUSIVE USE OF YOUR ENTITY. ANY DIVULGING OF THIS DATA TO A THIRD PARTY IS PROHIBITED	 DATE: 02/24/23
REVISION 2	-		
REVISION 3	-		
REVISION 4	-		
REVISION 5	-		
REVISION 6	-		



705 13TH STREET, LAKE PARK, FL  
800-848-6652

# Kern County Bakersfield, California

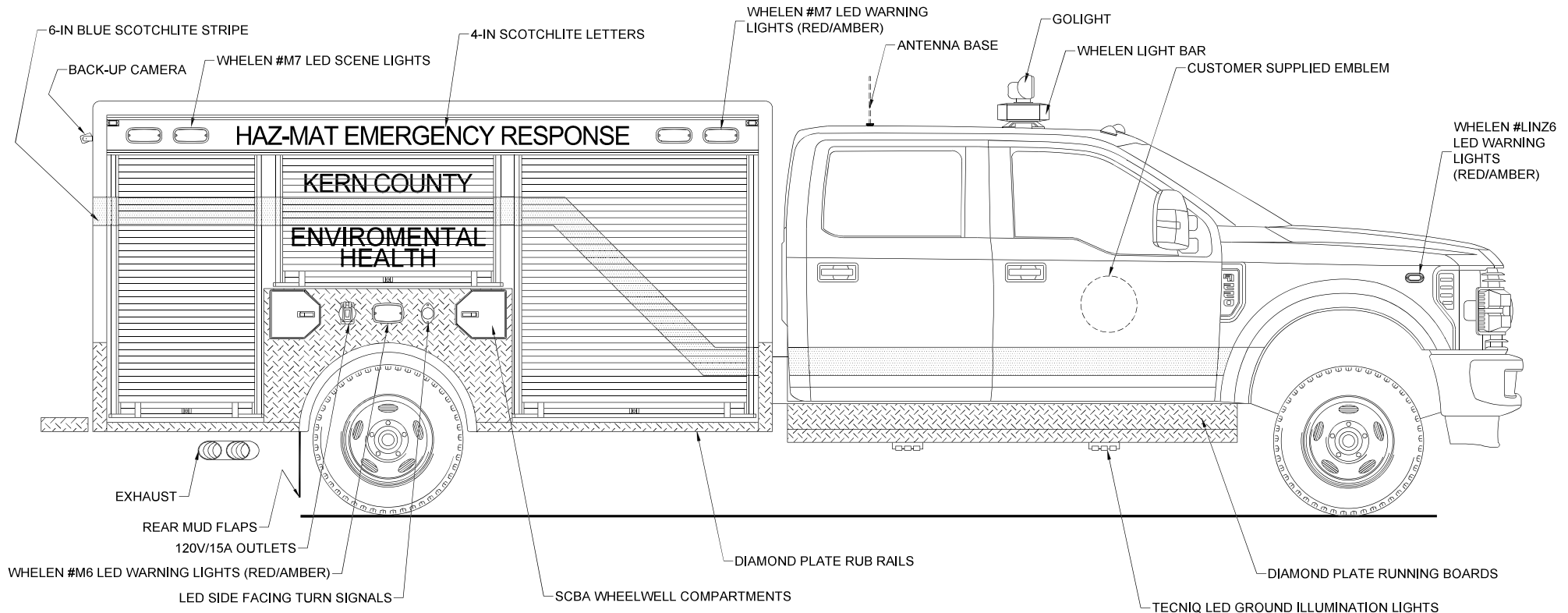

## Curbside Overall

### PRODUCTION

**NOTICE:** THIS DRAWING IS A REPRESENTATION OF THE VEHICLE AND/OR COMPONENTS AS DESCRIBED IN THE SPECIFICATIONS FOR THE DATE SHOWN. EVI RESERVES THE RIGHT TO MAKE CHANGES, AS NECESSARY, DURING THE PRODUCTION PROCESS TO ACCOMMODATE BEST MANUFACTURING PROCESSES AND TO ENSURE WE PROVIDE A CONSISTENTLY HIGH QUALITY PRODUCT.

REVISION 1	NS - 02/24/23 PR	THESE DESIGN/ENGINEERING DRAWING(S) ARE THE PROPERTY OF EMERGENCY VEHICLES INC. THEY ARE PROPRIETARY AND ARE FOR THE EXCLUSIVE USE OF YOUR ENTITY. ANY DIVULGING OF THIS DATA TO A THIRD PARTY IS PROHIBITED.	
REVISION 2	-		
REVISION 3	-		
REVISION 4	-		
REVISION 5	-		
REVISION 6	-		

DATE: 02/24/23



705 13TH STREET, LAKE PARK, FL  
800-848-6652

# Kern County Bakersfield, California

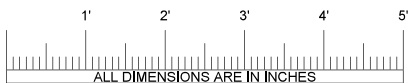
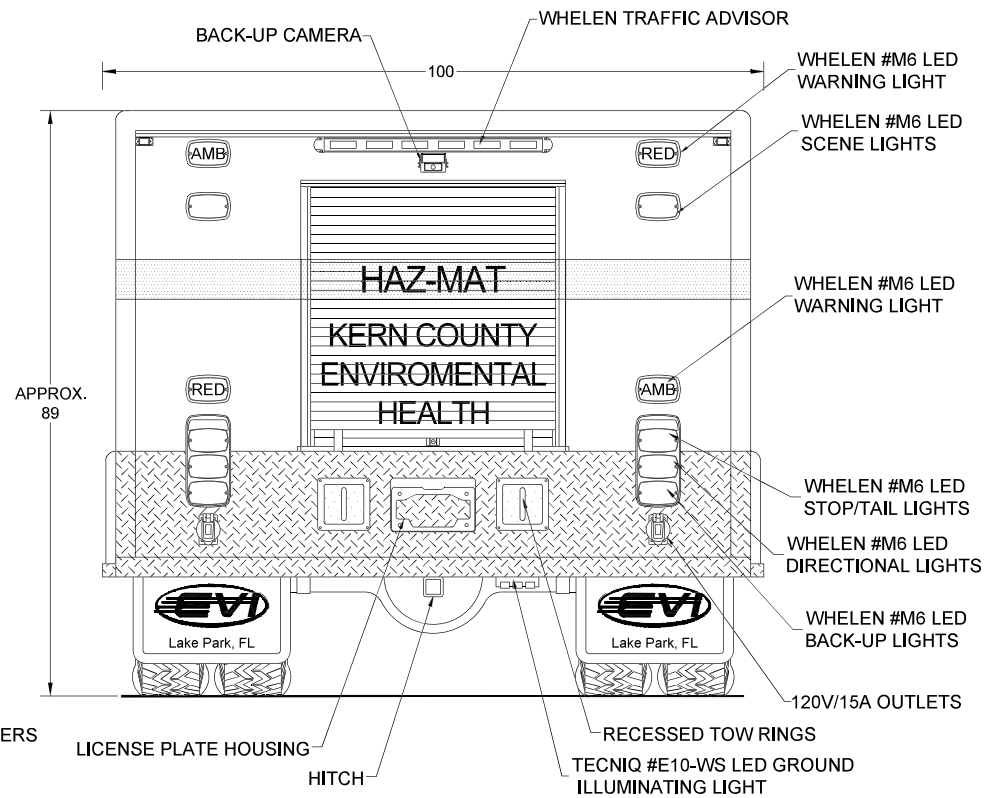
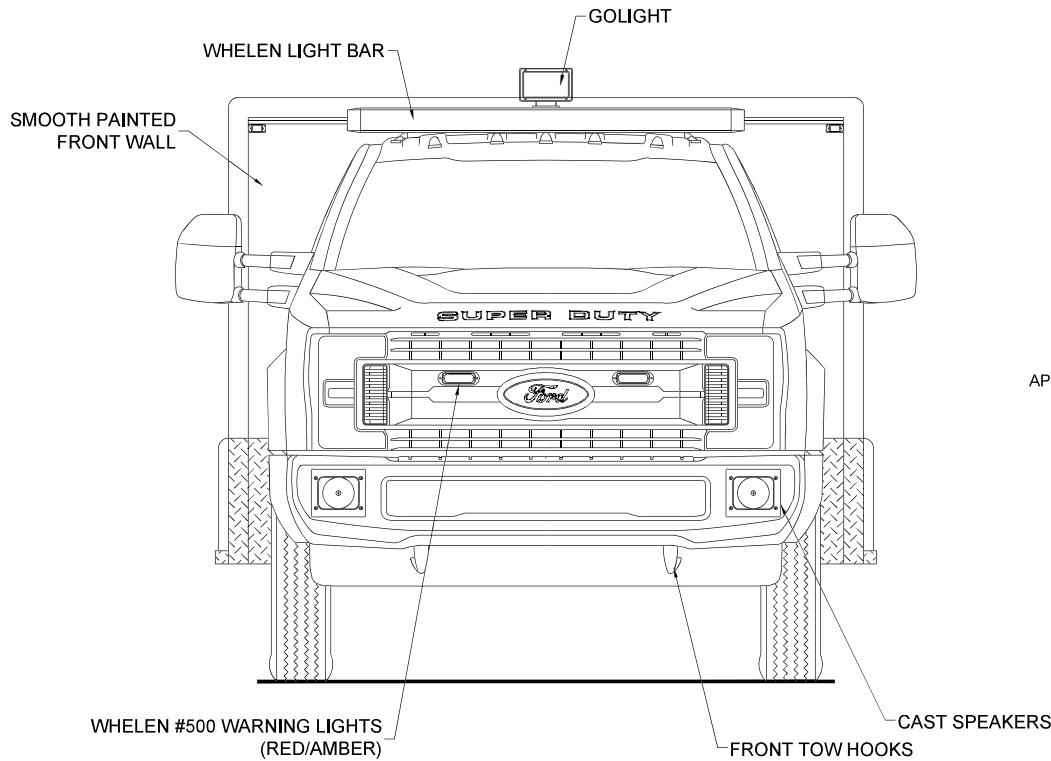

## Front & Rear Views

### PRODUCTION

**NOTICE:** THIS DRAWING IS A REPRESENTATION OF THE VEHICLE AND/OR COMPONENTS AS DESCRIBED IN THE SPECIFICATIONS FOR THE DATE SHOWN. EVI RESERVES THE RIGHT TO MAKE CHANGES AS NECESSARY DURING THE PRODUCTION PROCESS TO ACCOMMODATE BEST MANUFACTURING PRACTICES AND TO ENSURE WE PROVIDE A CONSISTENTLY HIGH QUALITY PRODUCT.

REVISION 1	NS - 02/24/23 PR	THESE DESIGN/ENGINEERING DRAWING(S) ARE THE PROPERTY OF EMERGENCY VEHICLES INC. THEY ARE PROPRIETARY AND ARE FOR THE EXCLUSIVE USE OF YOUR ENTITY. ANY DIVULGING OF THIS DATA TO A THIRD PARTY IS PROHIBITED.	 DATE: 02/24/23
REVISION 2	-		
REVISION 3	-		
REVISION 4	-		
REVISION 5	-		
REVISION 6	-		



705 13TH STREET, LAKE PARK, FL  
800-848-6652

# Kern County Bakersfield, California

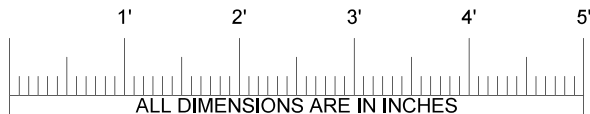
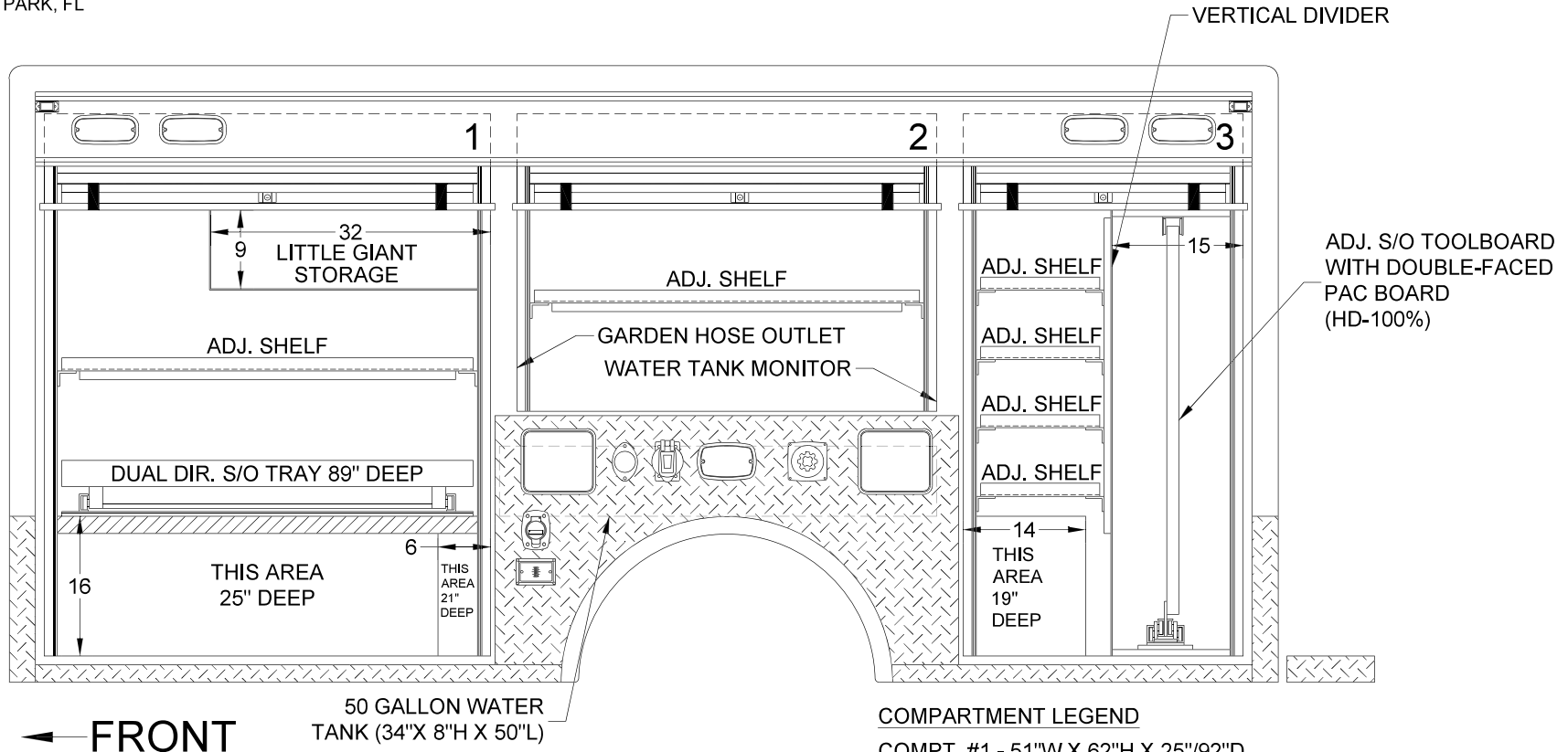

Streetside Body

PRODUCTION		
NOTICE: THIS DRAWING IS A REPRESENTATION OF THE VEHICLE AND/OR COMPONENTS AS DESCRIBED IN THE SPECIFICATIONS FOR THE DATE SHOWN. EMI RESERVES THE RIGHT TO MAKE CHANGES AS NECESSARY DURING THE PRODUCTION PROCESS TO ACCOMMODATE BEST MANUFACTURING PROCESSES AND TO ENSURE WE PROVIDE A CONSISTENTLY HIGH QUALITY PRODUCT.		
REVISION 1	NS - 02/24/23 PR	THESE DESIGN/ENGINEERING DRAWINGS ARE THE PROPERTY OF EMERGENCY VEHICLES, INC. THEY ARE PROPRIETARY AND ARE FOR THE EXCLUSIVE USE OF YOUR ENTITY. ANY DIVULGING OF THIS DATA TO A THIRD PARTY IS PROHIBITED.
REVISION 2	-	
REVISION 3	-	
REVISION 4	-	
REVISION 5	-	
REVISION 6	-	
		DATE: 02/24/23