

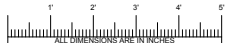

705 13TH STREET, LAKE PARK, FL
800-848-6652

Medical Testing Unit Middlesex County

REVISED
01-13-22

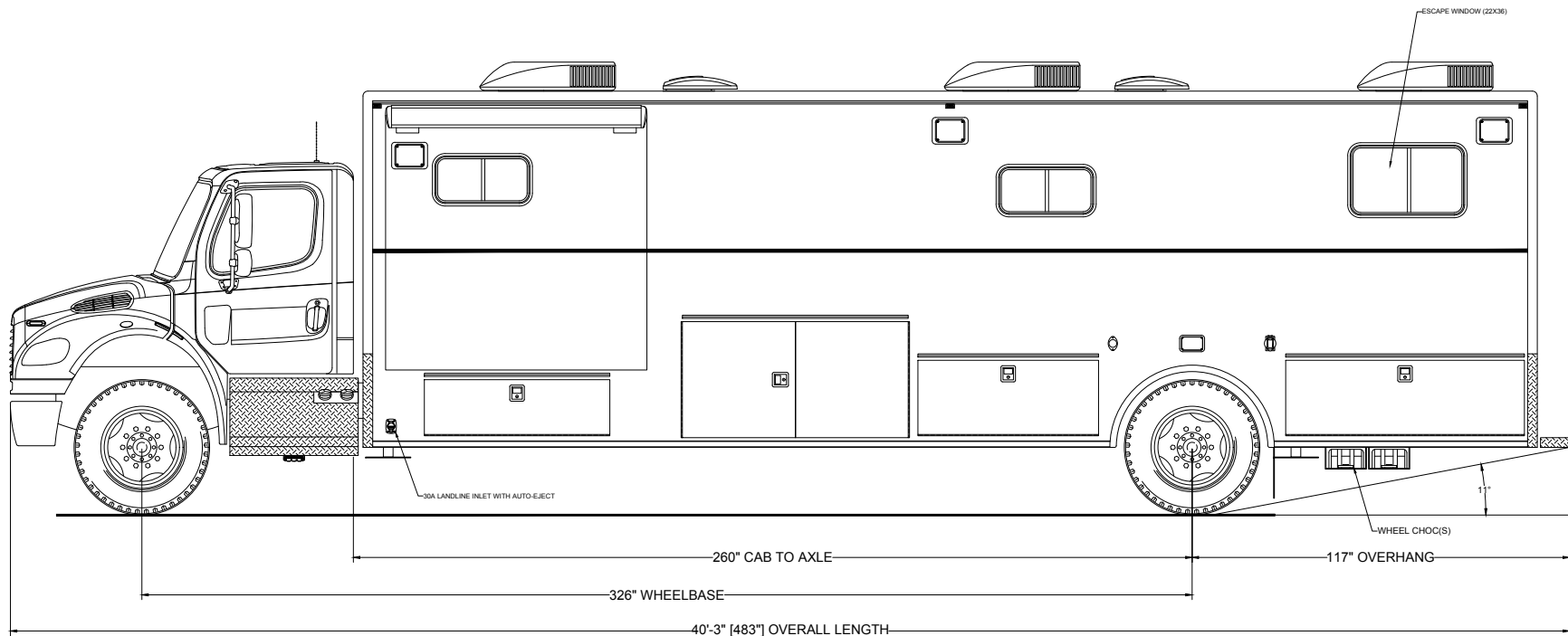

Streetside Overall

NOTICE
THIS DRAWING IS A REPRESENTATION OF THE VEHICLE AND/OR COMPONENTS AS DESCRIBED IN THE SPECIFICATIONS PER THE DATE SHOWN. EVI RESERVES THE RIGHT TO MAKE CHANGES, AS NECESSARY, DURING THE PRODUCTION PROCESS TO ACCOMMODATE BEST MANUFACTURING PROCESSES AND TO ENSURE WE PROVIDE A CONSISTENTLY HIGH QUALITY PRODUCT

REVISION 1	NS - 02/10/2021
REVISION 2	NS - 04/28/2021
REVISION 3	NS - 01/13/2022
REVISION 4	
REVISION 5	
REVISION 6	

THESE DESIGN/ENGINEERING DRAWING(S) ARE THE PROPERTY OF EMERGENCY VEHICLES, INC. THEY ARE PROPRIETARY, AND ARE FOR THE EXCLUSIVE USE OF YOUR ENTITY. ANY DIVULGING OF THIS DATA TO A THIRD PARTY IS PROHIBITED.

DATE: 12/11/20



705 13TH STREET, LAKE PARK, FL
800-848-6652

REVISED
01-13-22

*Medical Testing Unit
Middlesex County*

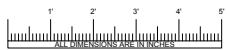
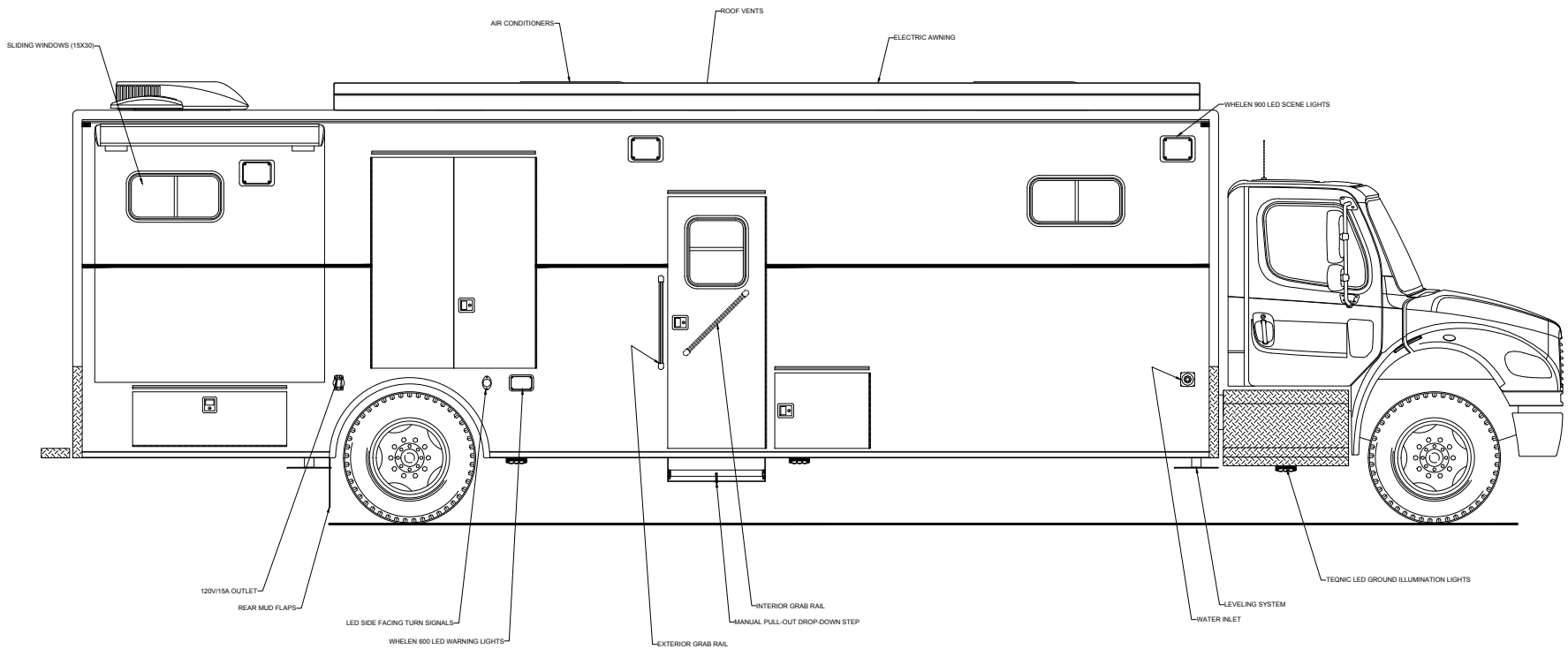

Curbside Overall

NOTICE
THIS DRAWING IS A REPRESENTATION OF THE VEHICLE AND/OR COMPONENTS AS DESCRIBED IN THE SPECIFICATIONS PER THE DATE SHOWN. EVI RESERVES THE RIGHT TO MAKE CHANGES, AS NECESSARY, DURING THE PRODUCTION PROCESS TO ACCOMMODATE BEST MANUFACTURING PROCESSES AND TO ENSURE WE PROVIDE A CONSISTENTLY HIGH QUALITY PRODUCT.

REVISION 1	NS	04/28/2021
REVISION 2	NS	08/27/2021
REVISION 3	NS	09/30/2021
REVISION 4	JPG	12/01/2021
REVISION 5	NS	01/13/2022
REVISION 6		

THESE DESIGN/ENGINEERING DRAWING(S) ARE THE PROPERTY OF EMERGENCY VEHICLES, INC. THEY ARE PROPRIETARY, AND ARE FOR THE EXCLUSIVE USE OF YOUR ENTITY. ANY DIVULGING OF THIS DATA TO A THIRD PARTY IS PROHIBITED.

DATE: 12/11/20



705 13TH STREET, LAKE PARK, FL
800-848-6652

Medical Testing Unit Middlesex County

REVISED
12-10-21

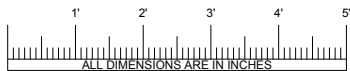
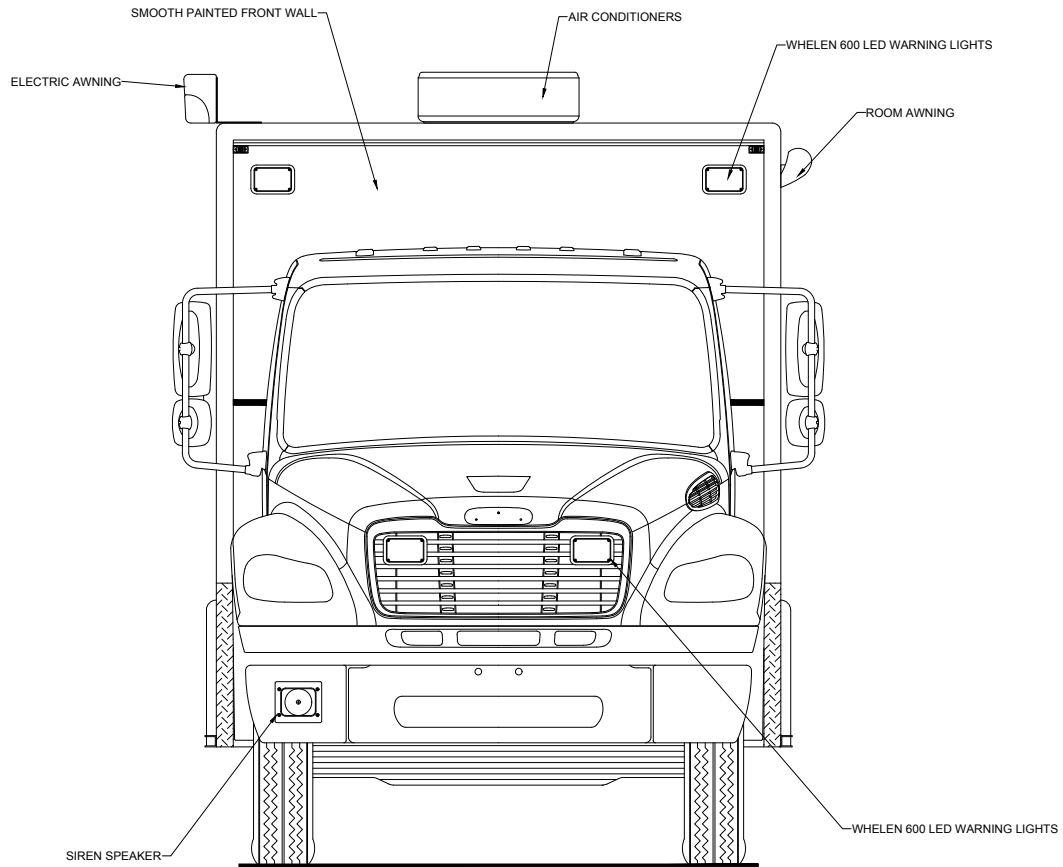

Front View

NOTICE		THESE DESIGN/ENGINEERING DRAWING(S) ARE THE PROPERTY OF EMERGENCY VEHICLES, INC. THEY ARE PROPRIETARY, AND ARE FOR THE EXCLUSIVE USE OF YOUR ENTITY. ANY DIVULGING OF THIS DATA TO A THIRD PARTY IS PROHIBITED.
THIS DRAWING IS A REPRESENTATION OF THE VEHICLE AND/OR COMPONENTS AS DESCRIBED IN THE SPECIFICATIONS PER THE DATE SHOWN. EVI RESERVES THE RIGHT TO MAKE CHANGES, AS NECESSARY, DURING THE PRODUCTION PROCESS TO ACCOMMODATE BEST MANUFACTURING PROCESSES AND TO ENSURE WE PROVIDE A CONSISTENTLY HIGH QUALITY PRODUCT.		
REVISION 1	NS - 02/10/2021	
REVISION 2	NS - 09/30/2021	
REVISION 3	JPG - 12/10/2021	
REVISION 4		
REVISION 5		 DATE: 12/11/20
REVISION 6		



705 13TH STREET, LAKE PARK, FL
800-848-6652

REVISED
02/24/22

Medical Testing Unit Middlesex County

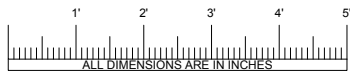
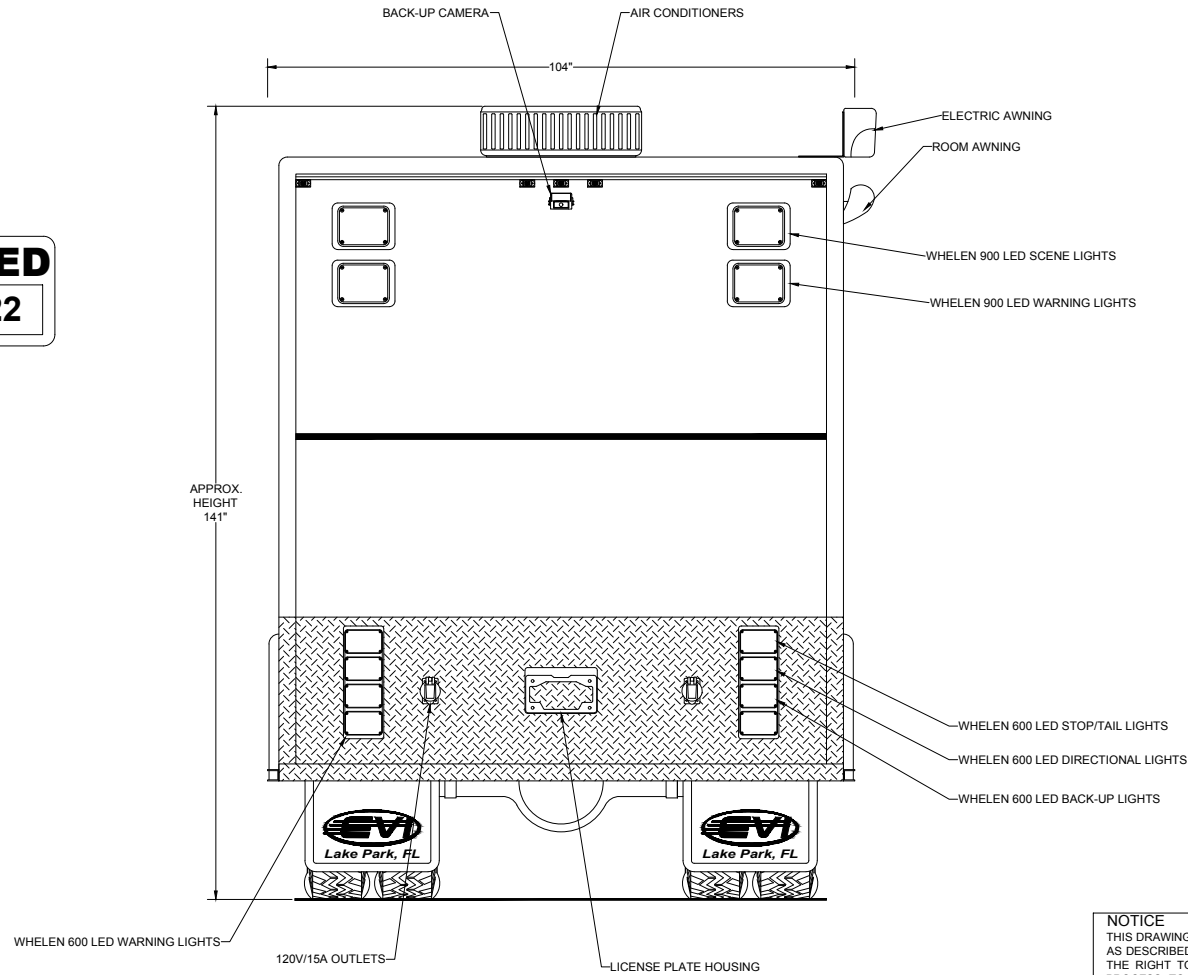

Rear View

NOTICE
THIS DRAWING IS A REPRESENTATION OF THE VEHICLE AND/OR COMPONENTS AS DESCRIBED IN THE SPECIFICATIONS PER THE DATE SHOWN. EVI RESERVES THE RIGHT TO MAKE CHANGES, AS NECESSARY, DURING THE PRODUCTION PROCESS TO ACCOMMODATE BEST MANUFACTURING PROCESSES AND TO ENSURE WE PROVIDE A CONSISTENTLY HIGH QUALITY PRODUCT

REVISION 1	NS	02/10/2021
REVISION 2	NS	09/30/2021
REVISION 3	JPG	12/10/2021
REVISION 4	JPG	02/24/2022
REVISION 5		
REVISION 6		

THESE DESIGN/ENGINEERING DRAWING(S) ARE THE PROPERTY OF EMERGENCY VEHICLES, INC. THEY ARE PROPRIETARY AND ARE FOR THE EXCLUSIVE USE OF YOUR ENTITY. ANY DIVULGING OF THIS DATA TO A THIRD PARTY IS PROHIBITED.

[Signature] DATE: 12/11/20