

*EMERGENCY VEHICLES, INC.*

*City of Tampa  
Tampa, Florida*

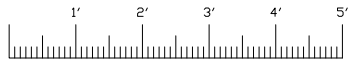
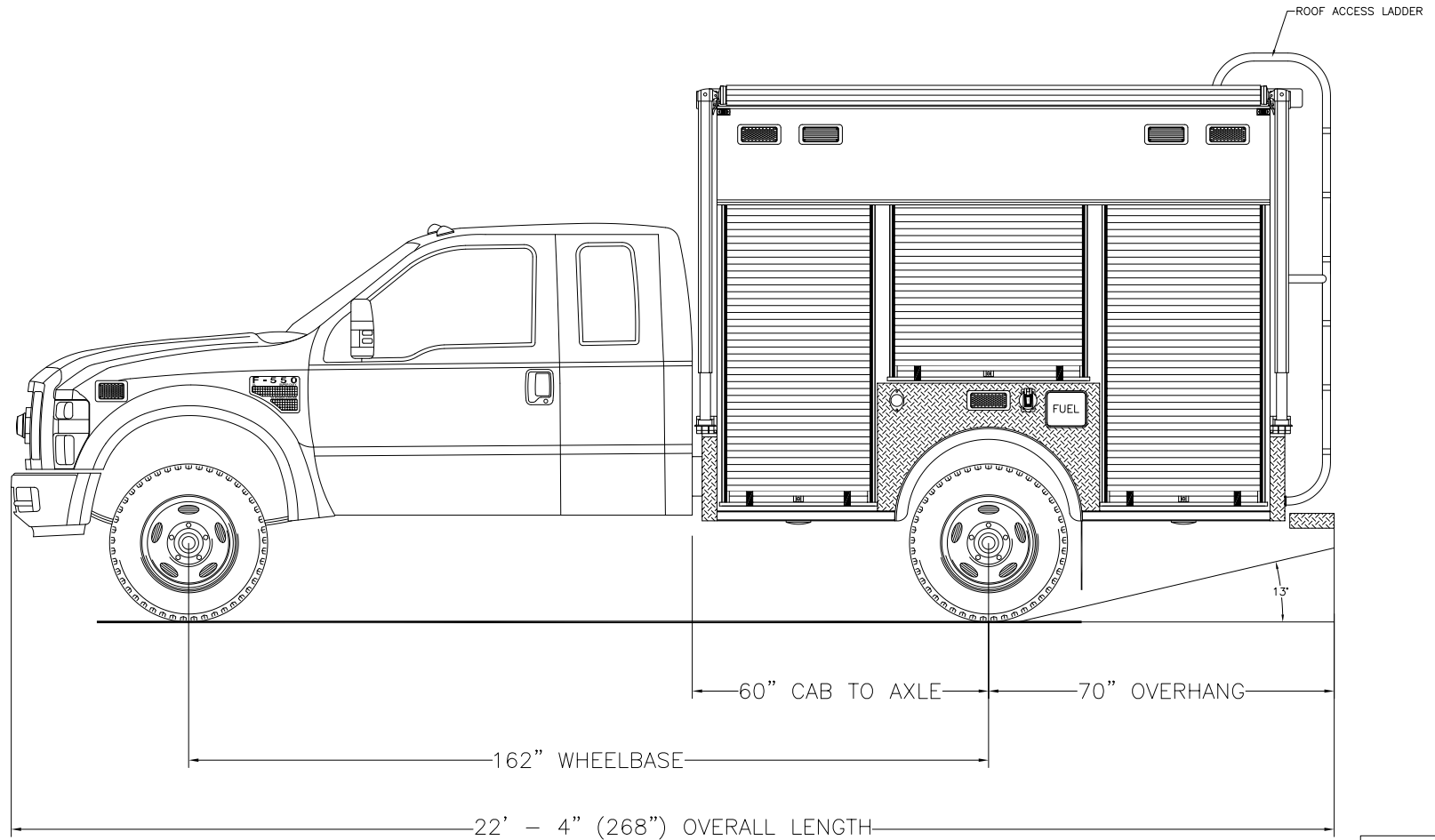

*Streetside Overall*

THESE DESIGN/ENGINEERING DRAWING(S) ARE THE PROPERTY OF EMERGENCY VEHICLES, INC. THEY ARE PROPRIETARY, AND ARE FOR THE EXCLUSIVE USE OF YOUR ENTITY. ANY DIVULGING OF THIS DATA TO A THIRD PARTY IS PROHIBITED.

*[Signature]* DATE: 11/16/07

REVISION 1	-
REVISION 2	-
REVISION 3	-
REVISION 4	-
REVISION 5	-

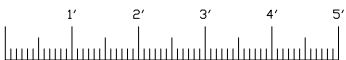
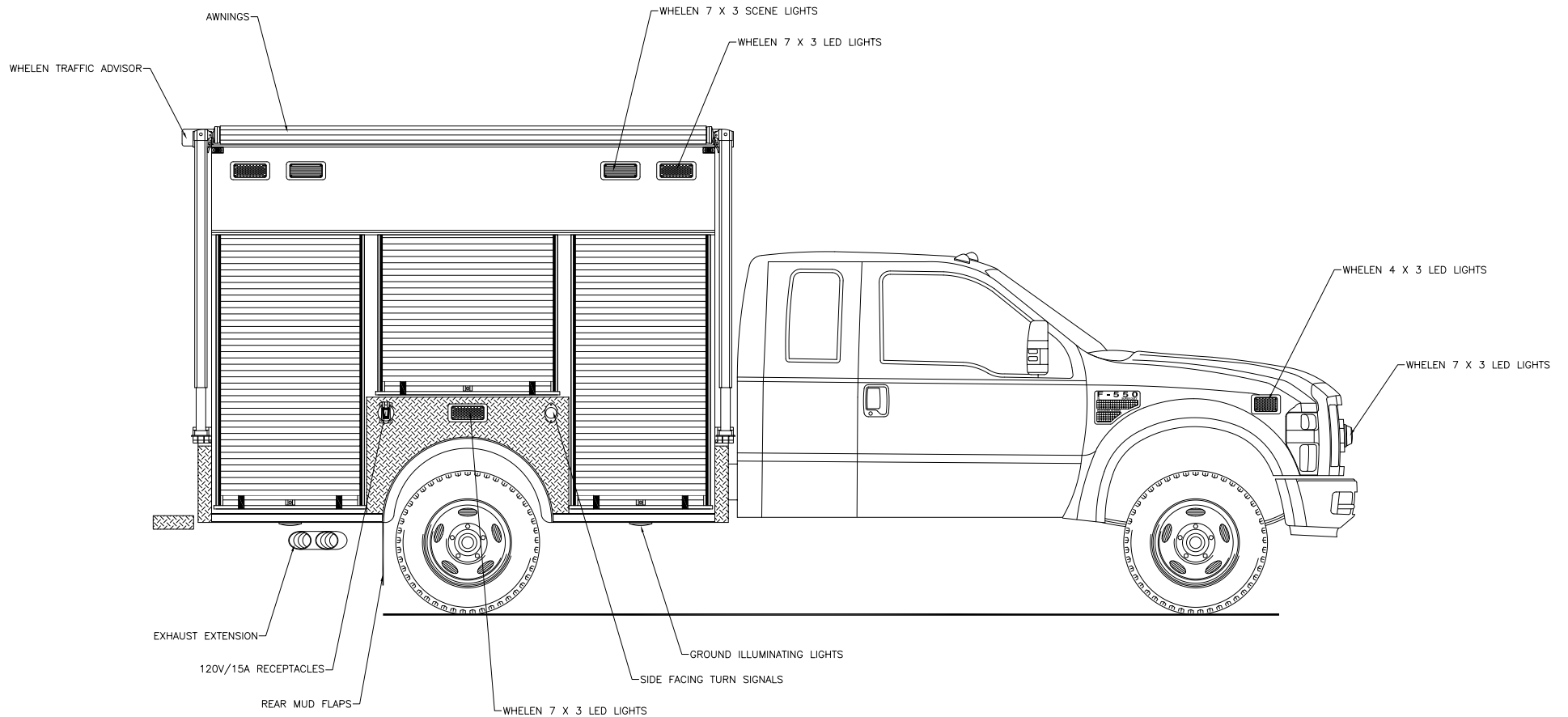

*Curbside Overall*

THESE DESIGN/ENGINEERING DRAWING(S) ARE THE PROPERTY OF EMERGENCY VEHICLES, INC. THEY ARE PROPRIETARY, AND ARE FOR THE EXCLUSIVE USE OF YOUR ENTITY. ANY DIVULGING OF THIS DATA TO A THIRD PARTY IS PROHIBITED.

*[Signature]* DATE: 11/16/07

REVISION 1	-
REVISION 2	-
REVISION 3	-
REVISION 4	-
REVISION 5	-

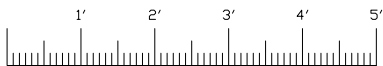
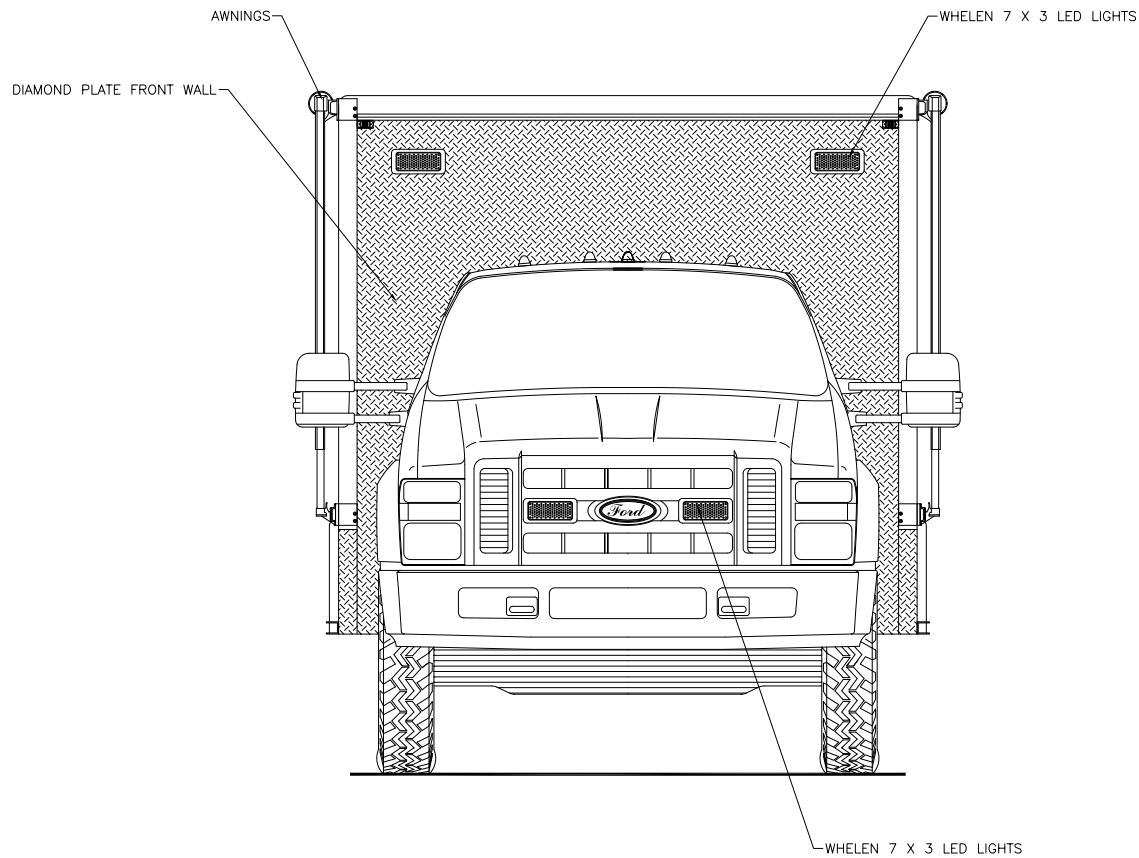

*Front View*

THESE DESIGN/ENGINEERING DRAWING(S) ARE THE PROPERTY OF EMERGENCY VEHICLES, INC. THEY ARE PROPRIETARY, AND ARE FOR THE EXCLUSIVE USE OF YOUR ENTITY. ANY DIVULGING OF THIS DATA TO A THIRD PARTY IS PROHIBITED.

*[Signature]* DATE: 11/16/07

REVISION 1	-
REVISION 2	-
REVISION 3	-
REVISION 4	-
REVISION 5	-

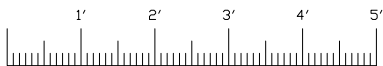
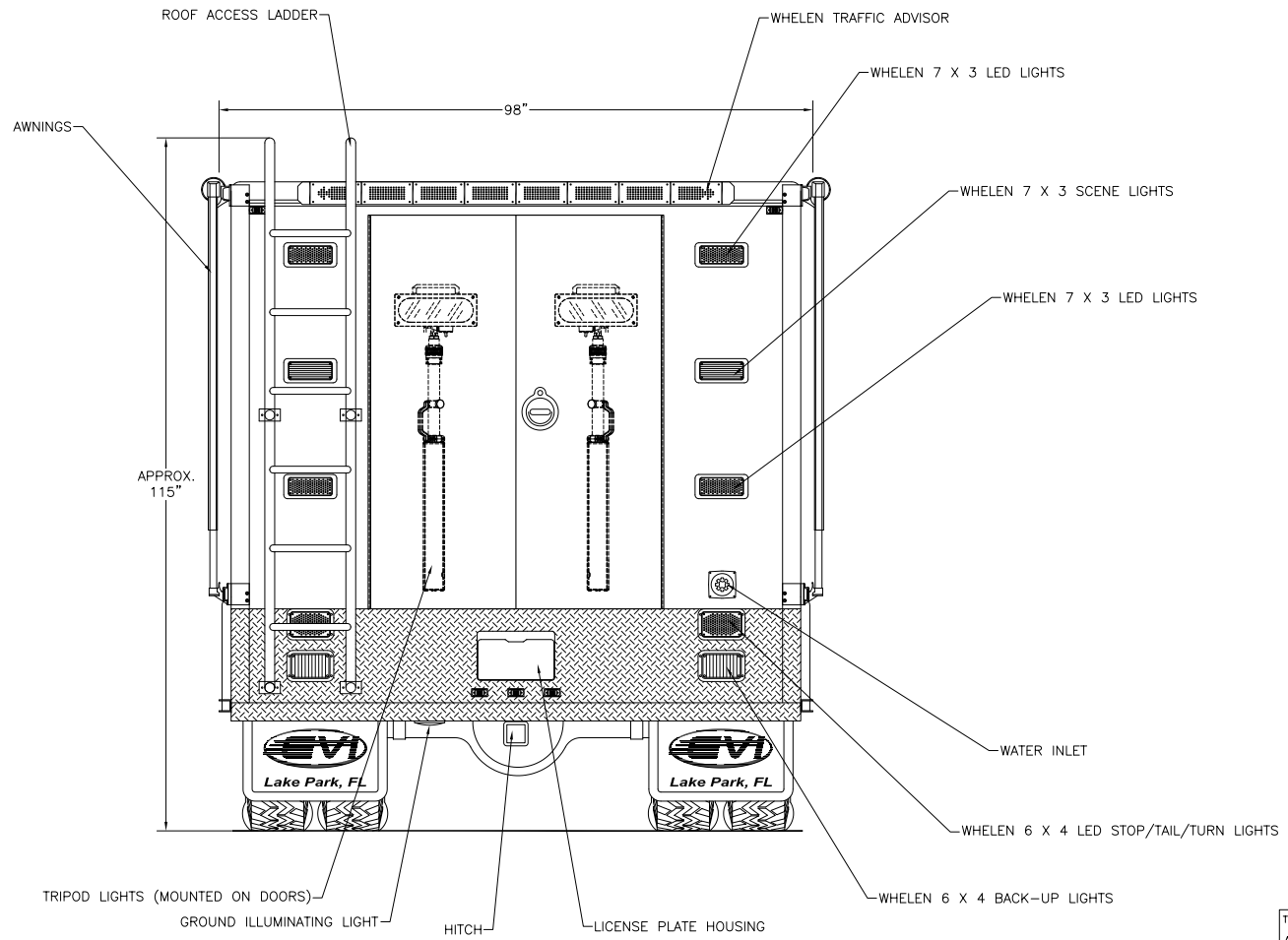

*Rear View*

THESE DESIGN/ENGINEERING DRAWING(S) ARE THE PROPERTY OF EMERGENCY VEHICLES, INC. THEY ARE PROPRIETARY, AND ARE FOR THE EXCLUSIVE USE OF YOUR ENTITY. ANY DIVULGING OF THIS DATA TO A THIRD PARTY IS PROHIBITED.

*[Signature]* DATE: 11/16/07

REVISION 1	-
REVISION 2	-
REVISION 3	-
REVISION 4	-
REVISION 5	-

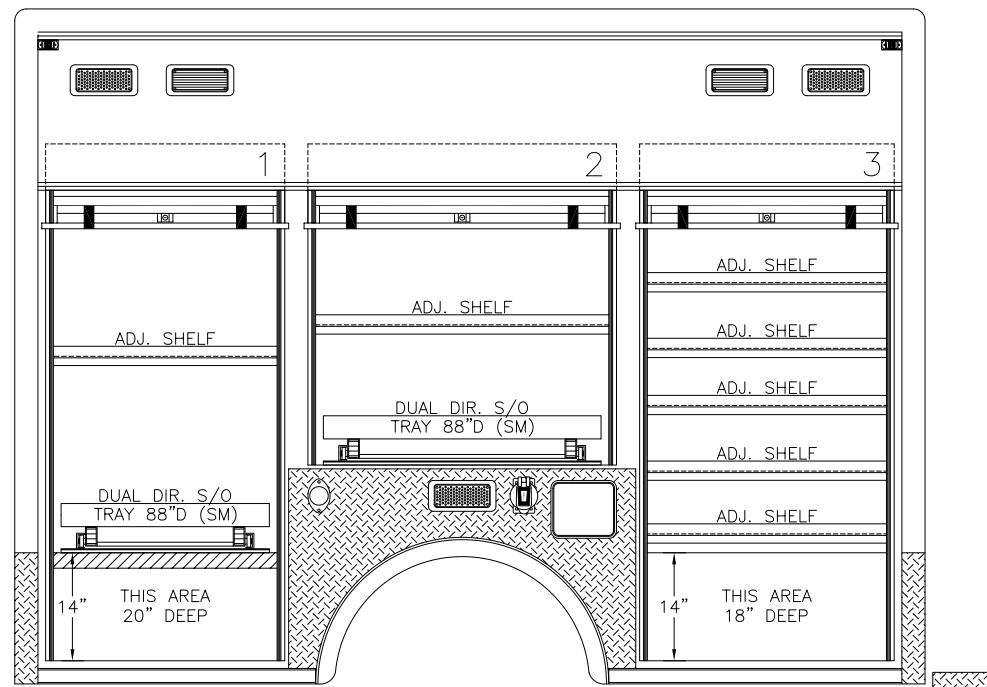

← FRONT

COMPARTMENT LEGEND  
 COMPT. #1 - 31"W X 67"H X 20"/90"D  
 COMPT. #2 - 40"W X 41.625"H X 90"D  
 COMPT. #3 - 33"W X 67"H X 18"/20"D

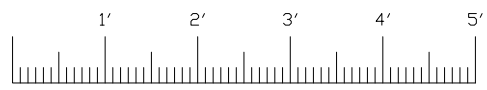

*Streetside Body*

THESE DESIGN/ENGINEERING DRAWING(S) ARE THE PROPERTY OF EMERGENCY VEHICLES, INC. THEY ARE PROPRIETARY, AND ARE FOR THE EXCLUSIVE USE OF YOUR ENTITY. ANY DIVULGING OF THIS DATA TO A THIRD PARTY IS PROHIBITED.

*[Signature]* DATE: 11/16/07

REVISION 1	-
REVISION 2	-
REVISION 3	-
REVISION 4	-
REVISION 5	-

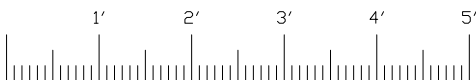
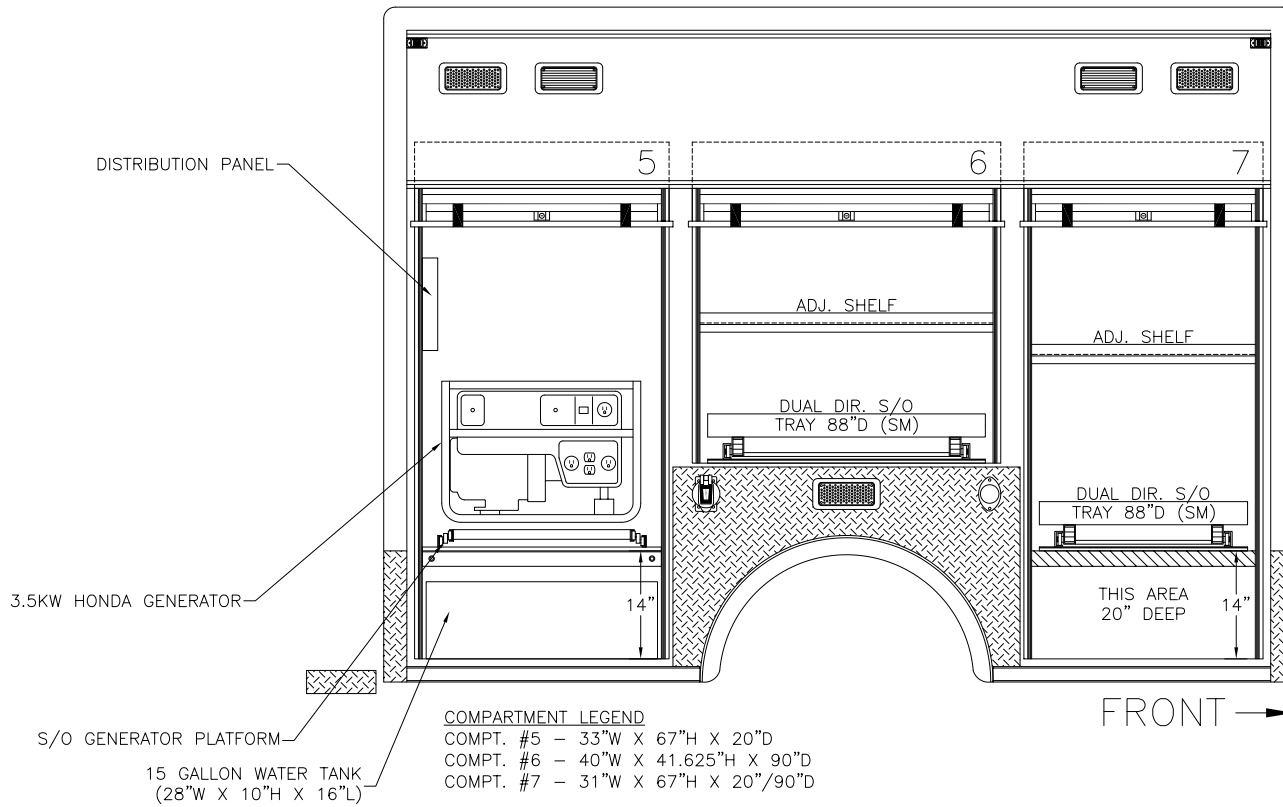

*Curbside Body*

THESE DESIGN/ENGINEERING DRAWING(S) ARE THE PROPERTY OF EMERGENCY VEHICLES, INC. THEY ARE PROPRIETARY, AND ARE FOR THE EXCLUSIVE USE OF YOUR ENTITY. ANY DIVULGING OF THIS DATA TO A THIRD PARTY IS PROHIBITED.

*[Signature]* DATE: 11/16/07

REVISION 1	-
REVISION 2	-
REVISION 3	-
REVISION 4	-
REVISION 5	-

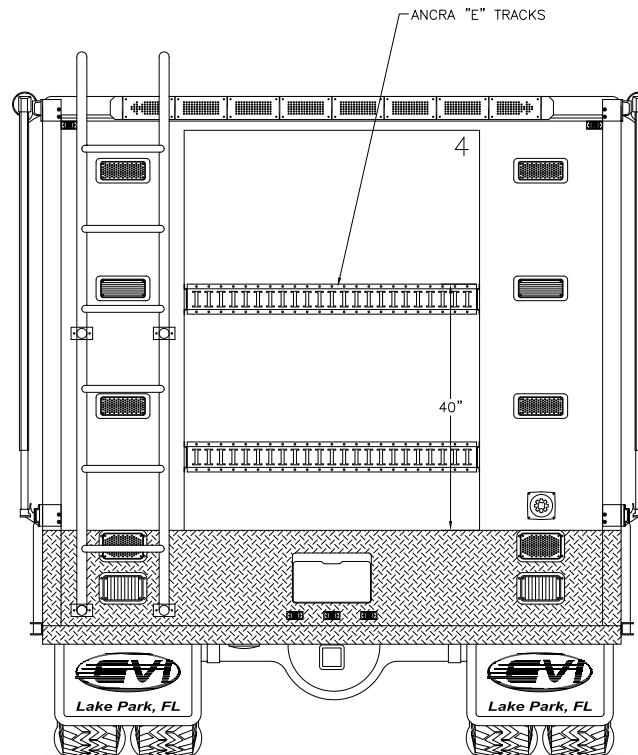

COMPARTMENT LEGEND  
COMPT. #4 - 48"W X 65"H X 37"D



Rear Open View

THESE DESIGN/ENGINEERING DRAWING(S) ARE THE PROPERTY OF EMERGENCY VEHICLES, INC. THEY ARE PROPRIETARY, AND ARE FOR THE EXCLUSIVE USE OF YOUR ENTITY. ANY DIVULGING OF THIS DATA TO A THIRD PARTY IS PROHIBITED.

*[Signature]* DATE: 11/16/07

REVISION 1	-
REVISION 2	-
REVISION 3	-
REVISION 4	-
REVISION 5	-

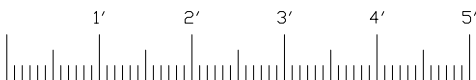
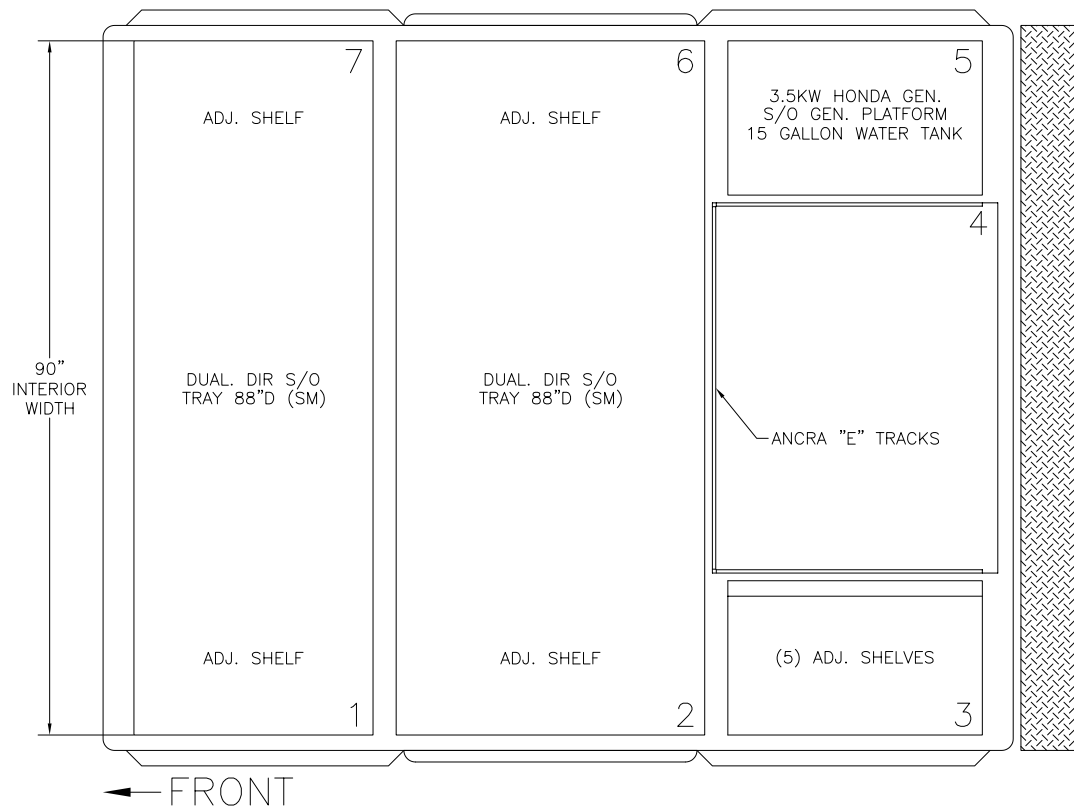

*Body Planview*

THESE DESIGN/ENGINEERING DRAWING(S) ARE THE PROPERTY OF EMERGENCY VEHICLES, INC. THEY ARE PROPRIETARY, AND ARE FOR THE EXCLUSIVE USE OF YOUR ENTITY. ANY DIVULGING OF THIS DATA TO A THIRD PARTY IS PROHIBITED.

*[Signature]* DATE: 11/16/07

REVISION 1	-
REVISION 2	-
REVISION 3	-
REVISION 4	-
REVISION 5	-